

PACKET STATUS REGISTER

March 1984
Number 10

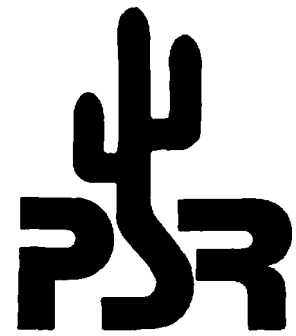

Tucson Amateur Packet Radio Corporation

The UoSAT-B spacecraft riding as a piggyback with the Landsat-D Prime satellite was successfully orbited March 1, 1984 from Spacecraft Launch Complex 2W (SLC-2W) at Vandenberg AFB. Launch was aboard a Delta 3920 vehicle, the 174th member of the highly successful Delta series. This marked Delta's 163 success -- an enviable 93.7% track record. NASA is now phasing out the expendable Delta series and replacing it with the reusable Shuttle.

Liftoff went like clockwork, within one second of the nominal 19:59 UT. Following the deployment of Landsat, the UoSAT spacecraft separated from the second stage of the launcher at about 21:11 UT. The telecommand station at the University of Surrey sent commands to initialize the spacecraft software and activate the 145.825 MHz beacon for a few seconds. These frames of telemetry showed that the spacecraft was in good health, so an additional command was sent to acquire about 5 minutes of data.

The spacecraft is in a nominal orbit with inclination 98 degrees, period 98.6 minutes and altitude 690 km. Improved orbital data should be available after the radars can separate UoSAT from Landsat and the launcher. The international designator for UoSAT-OSCAR-11 is 1984 0213; the NASA/NORAD catalog number will be known when we get the first Keplerian elements.

.....
I I I W E M A D E I T I I I

At last, JASNET.BAS program worked well without any problem.

Last night, in fact very early this morning, I made the final modification to the software which was required to make it run in connection with V3.1 ROMs. Then, the program gave us complete on the air electric-mail service!

I read/wrote nearly 20KB of information to/from the system to find that there was absolutely no garbage nor system-down. I changed baud rate between my CPU and TNC to 4800 bauds, and found that TAPR-TNC can swap data at this rate with DTE (host computer) without any problem.

It's interesting to see CRT when packets are sent at 4800 bauds. They appeared on the screen like a flush and I could realize what "packet" communication was!

Mean (logical) baud rate seemed to be some 400 - 500 bauds. The experiment was made via 70cm FM link between JI1ACI and JR1SWB. This link was far from optimum; JI1ACI's signals were not "full-quieting" at JR1SWB.

We still have a long way to go, but to say the least we have come to our initial goal. Without doubt, this is the first electric-mail system for radio amateurs in JA.

73's Miki JR1SWB

On April 15th, 1984, beginning at 10:30 A.M., Amateur Radio Relay League will hold its third international conference on Amateur Radio computer networking at Trenton State College, Trenton, NJ. It will be held along with the Trenton Computer Festival, held on April 14th (10 A.M. to 6 P.M.) and 15th (10 A.M. to 4 P.M.). If you are interested in computers and digital communications, plan to spend Saturday at the Computer Festival and Sunday at the ARRL conference. The specific location for the ARRL conference will be announced in the program for the Computer Festival and also in the registration area. No other registration fee is needed for the ARRL conference.

The speakers at the conference will be representing the Amateur Radio organizations that are active in packet-radio experimentation. They include: Amateur Radio Research and Development Corporation (AMRAD), The Florida Amateur Digital Communications Association (FADCA), New England Packet Radio Association (NEPRA), Pacific Packet Radio Society (PPRS), Radio Amateur Satellite Corporation (AMSAT), and Tucson Amateur Packet Radio Corporation (TAPR).

This will be an opportunity to examine and compare all amateur packet-radio terminal-node-controller (TNC) or packet-assembler/disassembler (PAD) systems. These include those developed by: AMRAD, Ashby & Son, GLB Electronics, Richcraft Engineering, TAPR, and VAUCG (Vancouver Amateur Digital Communications Group).

Packet-radio protocols, software and network development will be topics of high interest both at the conference and during informal conversations. Details of AX.25, the amateur version of the CCITT X.25 public-switched-data-network protocol, were presented at the second ARRL computer networking conference. Subsequent repeater-address expansion and other refinements will be considered at the April conference. Wide-area and global-networking proposals and development plans will be discussed.

Copies of the conference proceedings, including all papers presented, will be on sale at the conference. Extra copies of the proceedings will be available at ARRL Headquarters. The price per copy will be in OST magazine.

.....
We have received notification from NASA that our earnest money for the "GAS can" reservation was received and accepted. I will be forwarding papers to Harold. If anyone needs to refer to the payload the identification number, it is 501 in the earnest money queue.

.....
This has been a rather long issue, much has happened in the last few weeks. As spring and summer activities arrive, PSR would like to go along. Take some B/W pictures (3.5 X 3.5 or 3.5 X 5.0) for publication. We can also use line drawings or other graphics. **GET THE PICTURE ???**

Presidents Corner

by Lyle Johnson, WA7GXD

The TAPR Annual Meeting, reported on elsewhere in this issue of PSR, was considered an unqualified success by most attendees. If you missed it this year, mark your calendars now and plan on being in Tucson during the weekend of February 2 and 3, 1985!

The Board of Directors meeting, which took place on Saturday, February 4th, from about 8 PM until well after midnight, addressed many issues, including affiliation with local packet groups. A summarized set of minutes also appears elsewhere in this issue.

In case you aren't into reading minutes, the new board (same as the old with the exception of Pat Snyder, PSR editor, replacing John DuBois) elected the following officers to serve you during the coming year:

President	Lyle Johnson	WA7GXD
Exec V.P.	Peter Eaton	WB9FLW
Secretary	Heather Johnson	N7DZU
Treasurer	Chuck Green	N8ADI

In the area of statistics, over 500 TNCs have shipped and TAPR now has a membership of about 700! Quite a change from just over two years ago, when TAPR consisted of 0 TNCs and 6 people...

QUESTIONS

We have been receiving a lot of mail lately, and many of the questions relate to the TNC's availability, the status of the cabinet and when the Beta upgrade kits will be shipping.

As of last week (the week of March 4th), all paid up orders had shipped! There is of course a backlog of orders that are secured by \$25 deposit, but we expect to have enough kits to cover all orders, paid or secured, by mid-April.

I realize that it is hard to understand the delays, and many folks appear tired of hearing about parts being late from manufacturers, but the truth is simply that. If we sold the kit for a lot more money, we could afford to lay in a large stock, but we sell it very near our cost, so it has to pay for itself. However, a large, scheduled order has been placed for the next several months and TAPR should be able to ship from stock regularly, beginning in April.

The cabinets will be silk-screened this week. There was an error in the artwork for the silk-screen, and no one caught it until last week. The circuit board for the LEDs is being laid out now and the majority of the parts for the cabinet kits are en route. The remaining major task is that of documentation. Anyone want to write an assembly manual?

With a little luck, we should have a production cabinet at Dayton and be shipping the cabinets by May. Please note that that is NOT a promise!

Beta upgrade kits are nearly complete. We have most of the parts in stock now. As in the case of the cabinet, the major stumbling block at this point is a set of clear instructions. We hope to have this one in the hands of the Beta Coordinators during April, if all goes well.

The EPROM programmer seems to be plagued by minor difficulties. The prototype units have been working fine for several months, but the PC layout is not quite ready yet for release. It is close, however.

One lesson that we can learn from all of this is that, while it is nice to be the first person on the block with something new, PLEASE refrain from ordering anything until we announce that it is in fact AVAILABLE from TAPR in the PSR. This will avoid a lot of disappointment and grief.

The second lesson is, if you think that something should be done, VOLUNTEER to do it! That is how everything gets done in TAPR! TAPR is YOU!

ON OTHER FRONTIS

Since late July, 1983, there has been a small team of hardcore volunteers working on a project termed impossible by many -- UoSAT-2/OSCAR-11; or design, build, qualify and launch a sophisticated satellite in under 7 months!

The University of Surrey, England, under the leadership of Martin Sweeting, have been quietly (no time for publicity) building a satellite. And in the US and Canada, AMSAT has been sponsoring an experiment called DCE -- Data Communications Experiment -- to fly on UoSAT-2. Many of the key participants in the DCE project are TAPRites.

The DCE includes an NSC-800 microprocessor (a Z-80 look alike), 126 k-bytes of RAM (16k of it error correcting), various serial and parallel ports and the capability of controlling the spacecraft in the event of failure of the primary computer.

The intent of the DCE is to provide memory and processor technology evaluation for PACSAT, the upcoming packet radio satellite that AMSAT hopes to orbit in 1986. The immediate benefit that the DCE can provide is that of a flying mailbox for packet radio in 1984! The experiment will likely not be made available for general use (the memory and uplink channels are too restrictive for that), but it may be available on a limited basis for gateway operation, where a selected number of stations are given access to it and others can route their traffic through these gateways.

As this is being written, UoSAT/OSCAR-11 is in orbit, having been launched on 1 March 1984 from Vandenberg APB in California, in a polar orbit, sun-synchronous (passes overhead at about the same time every day -- 9:30 am and 9:30 pm).

On March 2nd the spacecraft developed a problem with the two-meter downlink beacon. As of this writing (9 March), the spacecraft remains non-functional, with teams in Surrey (led by Martin Sweeting) and Los Angeles (led by Harold Price) trying to turn off the malfunctioning beacon and turn on the 70-cm beacon instead (OSCAR-11 carries three beacons: 145.825 Mhz, 435.025 MHz and 2401 MHz).

Prior to the malfunction on the second day of its life, OSCAR-11 was performing flawlessly, and the DCE was working perfectly during the final ground tests. If the satellite can be rendered functional, we will have a unique facility for packet radio experimentation.

CONVENTIONS

If you are in the Trenton, NJ, area during the weekend of April 15, come to the 3rd ARRL Networking Conference. TAPR will have a booth and be out in force at Dayton. There is a Packet presentation/forum on Friday, April 27, from 3:45 PM until 6! See you there!

Central Iowa BBS

by Ralph Wallio, W0RPK

Following is our preliminary CBBS specification which we would like reviewed. We would appreciate suggestions for additions, deletions and changes before we lock the important concepts up in written code. Our intention is to write and debug locally with Central Iowa LAN users, find a couple of BETA sites to keep us honest and then distribute to all interested groups. Thanks for your interest and participation.

The CENTRAL IOWA TECHNICAL SOCIETY (CITS) has undertaken a project to design and implement a Computer Bulletin Board System (CBBS) for service in our PACKET RADIO Local Area Network (LAN). It is our intention to share our results (for a nominal donation), in the form of programmed floppy-disks and documentation, with the packet radio community such that other groups may consider this system for their local operations.

We intend to provide a complete hardware/software CBBS solution such that groups whose members are relatively inexperienced in microcomputing hardware, operating systems and applications programming could implement the system. Target hardware requirement will be fully documented and universally available. Software will be easy to configure, load and run. The system will be, to the greatest extent possible, self-administrating, requiring a minimum of System Operator (SYSOP) intervention.

Total hardware requirements will include the complete microcomputer, a Tuscon Amateur Packet Radio (TAPR) Terminal Node Controller (TNC), a dedicated VHF-FM transceiver and associated feedline and antenna. We intend to include basic Keyboard Send and Receive (KSR) terminal functions in the CBBS software such that the SYSOP could use the CBBS hardware as his personal TNC terminal. This would, under the right circumstances, save the cost of a dedicated TNC and RF arrangement. A conservative budget commitment is as follows:

CBBS micro	\$ 900 (Maximum)
CBBS software	50 (Est. CITS donation)
B+W monitor	50 (As available)
TAPR TNC	247 (current cost)
TNC enclosure	60 (TAPR est.)
Tranceiver	100 (10W/xtal controlled)
Antenna/feedline	100 (3 dB omni/Belden 8214)

Total	\$1507

We have selected the DIGITAL RESEARCH COMPUTERS single board computer kit as the target hardware. This equipment is inexpensive, universally available and heavily supported by independent user groups and journals. It will be used, along with attached peripherals, in an unmodified off-the-shelf configuration. Current approximate hardware costs are as follows:

Single board computer kit	\$ 279
SIO option	40
PIO option	20
CTC option	10
CP/M operating system	139
Siemens FD-100-8 8-inch disk drive	169
ASCII parallel output Keyboard	50
Power supply	100
Interconnection cables	30
Enclosure	50

Total	\$ 887

Application software will be written in fully-compiled DIGITAL RESEARCH CB-80 BASIC. Application program source listings will be available separately, to assist migration to other CP/M compatible hardware, but no "custom" compiled versions will be made by our group.

SYSTEM FEATURES

The application software will contain most CBBS features which are associated with dial-up modem accessed networks and several which are unique to our PACKET RADIO environment. All CBBS command level output will be formatted for 40-character lines.

AUTO-START - We will include an auto-start feature such that the system will automatically reload and run after an interruption in power.

LOGIN VIA TNC CONNECT MESSAGE - The amateur radio call sign contained in the TNC connect message (** CONNECTED TO K0CY) will be used for system access. A user list will be maintained by the SYSOP to associate an operator's first name and an optional two-level system access flag with each valid call (more on two-level access below).

REALTIME CLOCK - The CTC option will be used to provide a realtime clock feature which will be implemented for logging, message dating and message deletion routines. This clock will have to be set by the SYSOP whenever the system is powered up and periodically as it drifts from reality.

TWO-LEVEL ACCESS - Local Area Network (LAN) financial support arrangements may need the encouragement of limited CBBS access to ensure dues or access fees are paid. The SYSOP will have the ability to completely deny access by not including certain calls in the user table and, as an option, to limit access of certain calls to read-only status denying message origination capabilities or maintenance of a mailbox.

BEACON MESSAGE - The CBBS software will control the TNC beacon message and cause it to list the calls of all stations for whom it is holding unread messages. Additionally, it will list any new bulletins issued during the previous 72-hours.

CBBS traffic>>WA0JFS01 WA0LCK01 BULTN05<<de WA0WYW

When CBBS software is brought down for SYSOP maintenance or terminal features, the TNC beacon will be caused to say:

>>>CBBS is down - please try later<<<de WA0WYW

INTER-LAN TRUNKING - This system must eventually allow message origination to stations on other LANs and communicate with other similar trunking gateways. Current development efforts (by others) toward establishing level-3 (trunking) packet radio protocols are not complete, but it is assumed that some type of Front End Processor (FEP) will be associated with all trunks. This FEP, regardless of whether it is associated with high-frequency (HF) forward error correcting (FEC) channels, AMSAT OSCAR 10 channels or a wideband packet radio microwave backbone, would handle all packet assembling and disassembling thereby eliminating all but the simplest message formatting procedures to be followed by the gateway.

(continued on page 4)

BBS Watch

By Pat Snyder WA0TTW

With the release of all those nice new Rev. 11 boards added to the previous number of Beta TNCs we are moving beyond an early problem with Packet Radio, someone to talk to. Most LAN sites have sufficient member stations that someone is around to connect with most any time. Yet it is still very difficult to leave a message for any particular person on the net. They may or may not have their station on frequency if there is only one rig for both voice and packet use, or a connection might be possible but no one is immediately available at the console. If this is the case, a short note can be left on that stations screen to be read when they get back. But it tends to scroll off the top when there is other traffic on the net. So there is no real way to be sure that the information got to where it was supposed to. That tends to defeat the overall purpose of packet.

Of course many local LANs have set up bulletin boards or mail box systems (the general term BBS is from Bulletin Board System). This provides a common place to drop off and pick up "mail" and general news items. The BBS is normally a program running on a microcomputer that is attached to the TNC. As far as the micro-system is concerned the TNC is nothing more than a modem, characters are sent and received under program control. A mail box can be a big help in keeping a large number of people informed of group activities ("broadcasting") by using bulletins that are displayed when someone first connects to the system, on the order of a QST. Also SIGs (Special Interest Groups) and individuals within the main body can keep in better contact ("Narrow-casting") by using submenus and specific mailing lists for those interested in a particular topic.

A BBS can be a very popular and beneficial addition to any LAN group. But due to the requirement of another computer system, one with fairly large mass storage capabilities, there is a certain amount of additional cost involved to get the entire operation going. We have hit on the functional equivalent of the days when there were a few people putting converted commercial FM equipment on the air and everyone needed a nice repeater to fill in the dead spots and tie the group together. In many cases these systems became group projects due to the cost and complexity.

These mail box operations are also an indication of the need for the next level of our packet communication system (Level 3) in the International Standards Organization network model. For it seems we are looking for a way to hook each individual node station to all the others in an orderly and easy to use fashion. This is really the desired end result of all of our work after all. To provide a reliable and efficient method for two individuals to communicate, whether they want to send large computer files or just chat. From this point of view the BBSs are not only nice, but a needed element in the growth of this mode.

From the previous comments there are several separate areas that need to be dealt with on the way to a running mail box system. First there is the need for additional hardware to run the BBS program, which takes us to the next point, the program itself. (Does each LAN group need to develop and test their own BBS package? I hope not...) There is one other item that needs to be addressed as well, the ability to put these two things together and bring a system up and keep it running. This in many cases is no small task in and of itself. Last but not least is the total expense for the preceding three. We never seem to be very far from the bottom line when it comes to

hobbies, yet there is still a lot that can be done without a large outlay of cash, as Tucson has so ably demonstrated with the TNC itself.

So then, our task becomes one of finding hardware that is usable, yet low in cost. And finding, or creating, a computer assisted communication package for that particular set of hardware. As usual the more systems that can make use of the program without major changes the less expensive it becomes for each user. This leaves us with a need to use somewhat standard hardware to help reduce the investment in the programming effort. Nothing new here, same situation most everyone else is in. Furthermore, there is that gray area half way between the raw hardware and the application, the operating system. Even if the physical hardware is identical for several users, just a difference in revision level of their operating systems can mean the application program might not run properly, or at all. The issue of type and style of operating system software is of key importance too!

These subjects can bring up heated debate when trying to resolve the "which is best" dilemma. For me there is really no difference, use whatever is available and works. Let's take a look at a couple of these points:

System Hardware

The current crop of PCalikes would make nice mail boxes. Other than for their cost there is no problem. This situation can be resolved in one of several ways. A group buys the system and runs it, somewhat akin to an area wide repeater system. The total cost of the two would be on the same order. Or an individual could set the system up on a fixed schedule basis. He would use it during part of the day and allow it to run as a BBS for the other part. Sort of time sharing the hardware between the two applications. It might be possible to arrange for a local computer or radio outlet to operate such a system as well. Several of the computer stores do that here in the Twin Cities. But then there may be a problem of how to return the favor to the store owner. The local store operated systems in town allow for the sale of merchandise that the store carries, this would not be possible on our packet system. One other form of this is true time sharing, some of the later operating systems allow for multiple tasks and users. The owner gets a cycle and the BBS gets a cycle.

If there isn't an Apple or IBM around handy to press into service, where can one get the needed equipment? Well there has been quite a few "low end" systems on the market of late (low end only in price). The Commodore 64 might work in a BBS set up. It would need the addition of floppy drives and the appropriate serial connections though. This applies just as well to TI 99/4As and the other under \$150 systems currently available at the various discount houses. All totaled the hardware would run in the \$500 area. So the price is not too bad, but each will still need its own version of a mail box program, as the instruction sets are different and so are the operating systems. Also most of these depend on the smaller format 5 1/4 inch disk for their mass storage. This is not the problem it used to be when that style first came to the market and allowed only 90kb of storage. Yet with an increasing number of users, the available space on the disks can be used up quite rapidly. If that happens then extra drives may need to be added to the system to take up the slack. That would have to be included in the overall cost of the system.

(continued on page 6)

There is another form of computer system that has emerged in the past few years that would fit into this price range, the Z-80 based single board CP/M system. It also seems to be headed for many peoples "most popular" list. Both kit and assembled units are offered. Most of these contain the full memory complement for the Z-80, in some cases there are two or more banks of 64K on board. Also the floppy controller and other devices needed to complete the system are all designed in. Some of these come from systems that have been planned for office and business use, the manufacturers have released the main computer board to the "hobby" crowd for some additional sales. So these systems were intended for hard use and have been through quite a bit of testing. (The XEROX card is one example)

Although the hardware can normally support 5 1/4 inch floppies, the larger 8 inch units are the type usually chosen for use with these single board computers. These drives are very reliable and rugged, with storage capacities from 250Kb to over 1 Mb per drive. With the recent market push for the thin line half height drives there are a large number of these floppy disk systems available for a very nominal fee. Here in town I ran across a bunch of the double sided units that were in excellent shape for less than \$150. These will provide 1 million bytes of storage and have the same cast metal frames as the earlier single sided drives. All in all a very reasonable price for that much mass storage. Also the computer boards themselves are not overly expensive, bare cards can be purchased or full parts kits. If the packet groups around the country were to decide on a particular type of system to buy I would not be surprised to find some quantity discounts available to us. A good sized users group supports these SBC (Single Board Computer) systems, providing us a means of keeping informed of changes and helpful ideas that would be of interest to all as we put these computers to use as mail boxes.

Several of the cards provide enough hardware support to allow more than one user to connect to the system at a time. This will be more and more important as our bulletin boards become more complex. If an area wants to tie their BBS into the local TTY channel, or connect an HF LAN to a VHF LAN, or perhaps have a telephone dial-in port so non-packet amateurs can be involved, then there will be a need for some type of multi-user system. Most of the lower cost pre-packaged computers do not provide for this type of operation.

There is even the strong possibility that your mail box can have a hard disk file added to allow for even greater storage. There have been several I have seen available in the \$300 to \$600 range, with storage of 10 to 40 Mb per drive. The type of connection from the drive to the computer on many of these units follows a standard called SASI. Some of the single board systems have this interface built onto the card. They are ready for the hard disk with very little extra investment. Here is where a bit of additional planning in the early stages of a groups BBS will pay back large rewards in the near future.

I feel that a better buy can be had with one form or another of single board computer system currently available. They allow for more open-ended growth and have been through a lot of user testing. Which, along with the in place users group support, can be very valuable to some of us who have never set up such a system before. If anyone in the packet groups around the country would be interested in getting together a group purchase of SBCs I would suspect it could be arranged. Let me know here at PSR and I will contact a few others who have already shown an interest in using them.

SOFTWARE

The hardware is certainly not the only issue to be considered when putting together a computer system. The operating system (OS) and application software have to be available as well.

Each of the newer home units comes with an operating system of some type. Even when a system is based on the same type of CPU, the OS will more than likely be entirely different. In this case a program created for one line of computer will have to be rewritten to some degree before it will perform its task on any of the competing brands. There might be a problem encountered in just getting the program from one system to another, as disk formats are usually not the same. You can't just put the disk in the drive and read the program. Either someone would have to type it in fresh from the keyboard or get it sent in by way of a communication port. These are troubles that everyone encounters when trying to get from one brand of machine to another, but there is another way to go at the situation.

Many of the mail box packages I have heard of are based on CP/M. It is THE popular OS for the 8 bit systems with many folks around that are familiar with its use and operation. Again this can be an advantage to a new user. Such wide spread popularity means that application programs, like our mail box, can be moved from place to place without too many changes. Furthermore, there are some standards as far as disk formats are concerned. In the single sided single density mode all CP/M 8 inch systems operate the same. So data and program files can be transferred with no problems. This is a big plus if you don't want to start from scratch putting together the programs to run your BBS. Since the older "8 bitters" are more plentiful and therefore less expensive, this operating system would be a natural for our use. There are versions of it that provide for multi-user systems as well, thus allowing for that important growth path. CP/M might not be perfect in many regards, but due to its widespread use and availability on less expensive computers it could fill our needs quite nicely.

As for the actual application programs that will make the hardware and operating system do what we want them to, there are some very nice BBS and mail box packages available. Some are free in the CP/M users group library as well as in other collections. There are also commercial programs that do this task, but are not for free. It would be a good idea to look at what each of these programs do, and how it does it. That's a great way to get ideas about how a BBS could be set up. Yet with our new mode of communication we don't fit a lot of the models that are considered normal with those other programs. It would be best to start out fresh and create a system just for our own use in our particular way.

This has been done by Lynn WB1UWT in California. He has put together a wonderful package and it is in use at several of the packet sites. Others are currently busy putting the final touches on their own programs. (See the Central Iowa Technical Society BBS article in this issue.) Just as there are a variety of ways to set up and run a repeater system, there are different opinions as to what is "best" for a BBS. I would expect to see many versions and variations abound in the next few months. Then perhaps a gradual drift toward a "standard" mail box after awhile.

So as with the AX-25 protocol the hardware is going to have to be fairly normalized to allow the software to make the rounds of the sites. We can't have our own "rules of the road" as far as packet handling is concerned, and we will make it tougher on ourselves if we use equipment for our BBS operation that is markedly different from the next person. (continued on page 23)

Comparison Shopping

by Joe Buswell, K5JB

This is part of an article Joe wrote for his local newsletter. The TNC comparisons and inter-connect experiences are very interesting. -- ED.

The first Terminal Node Controllers (TNC's) from both Tucson Amateur Packet Radio Corp. (TAPR) and GLB Electronics arrived last month!

To refresh your memory, TNCs go between a computer, or some other kind of terminal device, and a transceiver to permit sending information over the radio using state of the art packet switching techniques. It makes a connection with another TNC located somewhere and guarantees the information transferred is complete and correct. 3A node is a point on a network diagram where information enters and leaves the network. The first available TNCs were from a Vancouver B.C. group which pioneered the mode, (Vancouver Digital Communications Group, VADCG) and a Tucson AZ group (Tucson Amateur Packet Radio Corp.) that developed a kit based on a little different protocol called AX.25. The Vancouver group's protocol is called VADCG. Both protocols send blocks of information preceded with headers and trailers containing address, status, and error checking information.

Two TAPR boards arrived shortly after I did last month's column and they were promptly pounced on and assembled by Jim, KB5XN, and myself. It didn't take very long (six hours construction time each) and we had them on the air, testing. The first evening on the air was only partially successful because audio level settings were extremely critical. Even after finding settings that would work, something would happen and one or the other TNC would appear to go deaf. After a few days of considering the problem, Jim gave me his TNC so I could do some A-B comparison and side-by-side trouble shooting.

After a few hours of running down blind alleys, the problem turned out to be in the transmit audio characteristics of my Icom IC-230. Two things were happening. A monitoring receiver, used for reference purposes, showed a significant recovered audio difference between the IC-230 and an IC-2AT. Where the 1200 and 2200 Hz tones from the IC-230 were recovered at the same amplitude, these tones from the IC-2AT differed by 3dB or more, depending on drive level and automatic deviation limiter action. The higher frequency tone was at lower amplitude (as it should have been). The TNC's audio input filter circuit was designed assuming an audio recovery like that from the IC-2AT and was boosting the high tone from the IC-230, causing problems. After creating some roll off on the IC-230's transmitted audio, reliability jumped to over 95 percent packets recognized. (More on that later.)

This still was aggravating since the bench top environment should provide nearly 100% reliability. One other apparent problem was extended key-up delay required on the IC-230. A 560 ms delay time (between keying and sending data) had to be increased to 1020 ms. The rig was keying fast enough but the audio tones sounded slow in reaching full amplitude. After checking everything, and even looking around for a substitute XR-2206, I tried another trouble shooting technique from the old bag of tricks. Hook up another rig!

That did it! I called Jim and was telling him about it while one TNC was sending a beacon to the other. It must have sent 40 to 80 beacons without a hit while we marvelled over it.

After spending a little time documenting the results to this point, I went back and spent a little more time on the IC-230 problem. There had to be a simple reason why the thing was so cranky and why the audio seemed to have a reverse AGC. The answer was discovered after the pressure of getting the system on-line was relieved. (Isn't that often the case?) The rig was over deviating. Deviation level on that rig had been set a long time ago with a high dollar monitor and I was pretty sure it was limited to 5 KHz so had not suspected a thing wrong with that. However, when the transmitter was hit with the TNC's audio, it first transmitted an over-deviated signal which the receiver recovered and presented as reduced audio. (Turning the audio up a little more than the AGC could handle caused the 2200 Hz tone to go away completely!) What I first thought was some kind of reverse AGC was actually the transmitter's microphone circuit AGC bringing the deviation down, and thus back into the passband of the receiver.

The IC-230 is still presenting some problems but Jim and I are beginning to overcome them. There are some more thoughts on the subject later.

I don't regret having the problem (now) because it gave me an opportunity to closely review some of the circuitry. Had I been able to "drive it off the lot" it might have been quite some time before the novelty wore off and I started digging. (At least a couple of weeks.)

The third TNC, an assembled and tested unit from GLB, the synthesizer people, was so simple to get on line it was ridiculous. I ordered this one as soon as I saw the ad because (1) It is a hundred bucks cheaper than the TAPR TNC, and, (2) The next TNC's from TAPR won't be arriving until about February.

The two TNC's are as different as they can possibly be. Where TAPR used hardware to get SDLC (synchronous data link control), GLB did it all in software. The GLB (called PKI) TNC uses a Z-80A microprocessor running slightly less than 4 MHz. It's operating system is contained in a 2764 8K EPROM and it comes standard with 4K of RAM, which can be expanded.

Let's back up a little with the comparisons and start with the price. The TAPR kit costs \$242.00, the GLB comes assembled and tested at \$149.95. The TAPR TNC is somewhat bigger at 11 by 6.5 inches to the GLB's 4.5 by 9.5. The TAPR includes 3 voltage power supply, the GLB requires addition of a single 12 volt supply. The TAPR comes with all necessary connectors. The GLB does not. With the latter it is necessary to scrounge up a 40 pin, 1/10 in. centers edge connector or buy a couple of 10 pin connectors (\$2.95 ea. from GLB). GLB has all the necessary extra parts for a price. Cabinet, power supply, and connectors are available for about fifty three extra bucks, brings cost of a complete system up to around \$205.00, counting snipping.

It will be interesting to see what the TAPR board will cost if a commercial enterprise starts manufacturing it. Up to this point it has been a voluntary operation by a bunch of packet radio zealots, very professional bunch I might add.

Back to the comparisons...

The TAPR TNC contains an (almost) non-volatile RAM (I have had to reprogram mine twice but that's no big deal). One just types PERM after amateur call and other personalizations are (continued on page 8)

(COMPARISON continued from page 7)
entered, and it is done. The GLB has to have several parameters typed in on power-up.

A typical GLB session goes like:

```
Flip on the power.  
RETURN (this sets terminal baud rate)  
SBD (ignores open squelch)  
SCK5JB (sets my call in memory)  
SA3 (sets my VADCG address)
```

to make a connection...

```
SDKB5XN (the only other guy in town with  
packet)  
AC (to request a connect)
```

if connection is successful...

```
I (to insert text in buffer)  
Howdy Jim (the text)  
ESCAPE (end of text)  
AT (to transmit text)  
AD (to disconnect)  
MI (to send CW ID)
```

To do the same thing on the TAPR TNC, turn on the power and type:

```
CONNECT KB5XN (CW ID is automatic)
```

If connection is successful, type:

```
Howdy Jim
```

```
RETURN (packet is sent)
```

To disconnect, type:

```
DISC or simply D
```

9 1/2 minutes after you start, it sends another CW ID.

And that's it. Both of these things have a lot of commands. The TAPR has 73 and the GLB has over 30. Neither requires learning more than a few to get on the air. The great number of commands come into play when one decides to experiment with some of the available modes and variations.

On the other hand, since the GLB is not a kit, its documentation is rather sparse, containing twenty five printed pages and lacking a schematic of the thing. In case of trouble, a knowledgeable amateur could troubleshoot the analog circuits by examining the board and visually tracing out circuits. If one had on hand specifications for the devices contained on the GLB TNC he could probably set tone frequencies and find obvious defects but, by and large, this board would have to go back to GLB for repair. All the documentation says about three of the pots on the board is "factory adjustment" or "do not adjust". Both TNC's documentation are complete enough for a knowledgeable amateur radio operator to get them up and running but for a thorough understanding of what is going on the TAPR material is superior.

At the bottom of the first page of the GLB material is a reference to "Synchronous Packet Radio Using the Software Approach, Volume 1", Richcraft Engineering Ltd., #1 Wahmeda Industrial Park, Chautauqua NY 14722, \$22.00. This would probably be the reference to have if one is contemplating using a computer to emulate a Terminal Node Controller. It would also probably shed some light on how the GLB TNC works.

Neither TNC documentation contains source code for the operating system though the TAPR board itself contains a monitor that permits examining memory and performing most of the other

normally expected debugging features. The GLB accepts commands that permit some analysis and customization of the packet header but that is about it. The GLB does have one mode that I have not been able to duplicate on the TAPR. If commanded, it will go into 'Garbage' mode and display flawed packets. This is really helpful while getting set up and will be helpful also under noisy conditions because one can guess content of a message if only a few characters are hit but normal error checking won't permit display of a flawed packet at all. Because of this special feature, Jim is calling the GLB TNC the GIGO unit (Garbage In, Garbage Out).

The TAPR TNC contains 32 IC's and one power FET, the GLB contains 13 IC's and five transistors. While the TAPR unit will key a 200 ma push to talk line almost to ground zero with its power FET, the GLB will only handle 50 ma. An interface circuit will be necessary to key my IC-230 which develops 100 ma on the keying line. More on interfacing later.

The TAPR TNC runs both VADCG (Vancouver) and AX.25 (AMRAD) protocols. The GLB runs only the VADCG but is working on a PROM that will contain both. It is supposed to be available in January and will be a must because future expansion of packet radio will require the flexibility of AX.25. I have been unable to get the GLB to operate in repeater mode, either as a repeater or as a terminal, sending packets to the other TNC and back to itself. The TAPR board has been tested in this mode both in AX.25 and VADCG protocol.

Interfacing between the two TNCs and other equipment is slightly different. The TAPR board uses plus and minus 12 volts normally found in RS-232 circuits and includes RTS (request to send) and CTS (clear to send) circuits for hardware flow control. The GLB does not correctly use the RS-232 signalling standard. It uses zero and plus 12 volts instead of plus and minus voltages. Some computers and such are guilty of this also and should work fine unless the terminal equipment uses TTL levels of zero and plus 5 volts. One must be cautious to prevent damage from this incompatibility. Thus far, I have only used my Radio Shack Model 100 as a terminal on the GLB and there has not been any problem I am aware of. The model 100 does use plus and minus voltages on the RS-232 port but it seems to be satisfied when it sees a zero rather than minus.

The GLB connects to most computer and terminal equipment running from 45 to 9600 bits per second, ASCII or Baudot, though I doubt it will ever see more than 110 bps Baudot. I am having a bit of trouble losing characters dumped to it at 300 baud ASCII right after the carriage returns but I think I can work that out without going into the block data transfer mode. This mode will require writing an I/O driver for the computer that prefaces blocks with byte count and awaits a "go ahead on" prompt from the TNC. This stuff ain't for lightweights so ya wanna get ready to learn yer computing if you wanna play the game with this baby.

I don't think the TAPR board handles Baudot. ASCII data is handled from 50 to 19,200 bps and initial setting is established on power up with an auto baud routine. After communications is established, baud, parity, and word length are stored in ANOVRAM (almost NON-volatile RAM by Xicor) by the PERM command. Next power up recalls these values if the ANOVRAM is enabled and hasn't forgotten what it is supposed to be doing.

The TAPR board has ability to change serial port parameters on command. They actually change after a RESET command is given. During a one on one exchange with another amateur, it might be
(continued on page 9)

(COMPARISON continued from page 8)
 desirable to crank up the terminal baud rate to 1200 in order to not bottle neck data getting in and out of the computer. With all the messing around so far I have not caused any delay with the computer set at 300 Baud. To restore lower speeds it would be necessary to talk to the board at the higher baud rate or reset the thing. (This would be undesirable if connected to another TNC.)

The TAPR board seems to handle text dumped from the computer with no loss of characters. When its buffer is almost full it will issue an XOFF (defined by the user), or if hardware handshaking is chosen, will make CTS (clear to send) false until it has room in the buffer.

Speaking of buffers, the GLB TNC comes equipped with 4K of RAM which is shared by the operating system and transmit and receive buffers. The operating system needs about 200 bytes. A section between 250 and 1750 bytes is reserved for the transmit buffer. The rest of contiguous memory is available for receive buffering. The board is capable of being expanded with byte wide RAM or ROM to a 64K maximum.

The TAPR TNC comes equipped with 32K of ROM and 8K of RAM. With the mapping supplied, up to an additional 16K of RAM, ROM or whatever may be plugged into the TNC. Replacing the memory mapping decoder permits other configurations without modifying the board. 4K out of the possible 64K addressing of the 6809 processor is needed by the I/O memory mapping.

The NOVDRAM has two 64 byte blocks that are used for storing personal preferences that are to be read into RAM during power-up. The two blocks are switch selectable so two different sets of parameters can be readily available if the TNC is to be used for widely different applications.

If one is into radio Teletype, and is using a Baudot machine, the GLB board is capable of a nifty form of autostart operation. A circuit diagram is included that watches for data on the RS232 RXD (receive data) line. When it goes low, indicating data is arriving, it turns on the printer motor and holds it on as long as data is being received. This circuit is available from GLB for \$12.95. For that price they will probably send a circuit that works because the one on the documentation won't. While all the mark and space conventions are respected, the motor needs aren't. The motor needs to run when data is arriving and not when things are idle.

Both TNC documentations go into quite a bit of detail on how to connect to the transceiver equipment. Audio shaping is of serious concern because, since they are FM, these radios are being pushed to their limits to handle 1200 Baud FSK. There is a certain lack of standardization between designers regarding pre-emphasis, de-emphasis and in the case of phase modulation, pre-distorters. This is simply because specifications can be pretty sloppy as far as voice is concerned and the words still get through. Very few of my rigs have survived my critical ears (worn out as they are) without some kind of transmitter audio modification. It is true that we might expect the audio circuits to handle a 3 KHz tone at 5KHz deviation but that is a sinusoidal wave. In theory these conditions would require about 22 KHz bandwidth (Bandwidth equals two times the modulation frequency times the sum of modulation index plus two. Modulation index is deviation divided by modulation frequency.) A reasonably good 2 Meter receiver will have approximately fifteen KHz bandwidth in its IF section (design problem number one - not wide enough). The 1200 Hz shifting between 1200 and 2200 Hz tones would require an extremely wide bandwidth if it was instantaneous. In fact it is instantaneous when it starts out, but after it is filtered by both

transmitter and receiver circuits it is no longer a faithful representation of the waveform originally generated. Given the restraints of 5 KHz deviation and a receiver bandwidth in 15 KHz, we can only handle 1250 Hz modulating frequency. Guess what folks, that is only the fundamental of the supposed to be square wave. Ergo, sine wave from what was once a square wave. Our salvation comes from the XR-2206 which creates phase coherent FSK and the XR-2211 which watches for phase shift and snaps from one state to the other when it sees it. The transmitter and receiver circuits have to be doing their stuff for all this to work. Jim and I have experienced what happens if they aren't. Most obviously, if the 2200 Hz tone causes a significant drop in recovered signal at the receiver because of transmitter over deviation, it just doesn't work. Let the deviation creep up to 7 KHz and the 2200 Hz tone has significant sidebands out to 22 KHz. At the receiver, perceived signal strength is less because of IF trimming of four significant sidebands containing part of the transmitted energy (the 8.8 and 11 KHz ones).

Pre-emphasis is largely misunderstood by radio operators and the GLB documentation procreates this misunderstanding. Pre-emphasis is not done in FM circuits because of peculiarities of the human voice. It is done because of the peculiarities of FM in the presence of AM noise interference. (See N5MS's Sept. 82 C&E article for an in-depth discussion of pre- and de-emphasis.) FM can easily overwhelm lower frequency AM noise components but has difficulty with higher frequency noise components. The solution is to boost frequency modulation of higher audio frequencies. GLB recommends adding a de-emphasis circuit to the audio before sending it to the microphone circuit and suggests a 1 ms time constant. Normally, a 75 microsecond time constant is used for pre and de-emphasis but in this case, the recommended circuit is a good idea, even if for the wrong reasons. It simply stifles over deviation by the high tone.

Another problem KB5XN and I are experiencing in this area is due to the peculiar characteristics of a phase modulated rig. We are having a devil of a time getting IC-230's to transmit properly deviated tones that 'sound' loud enough. At this point, I suspect it is because those rigs are Phase modulated. Phase modulation characteristically FMs a signal more at higher frequencies. We are experiencing 3 to 6 dB stronger high frequency components from these rigs than from any others we have tried (IC-225 and Kenwood TS-700, all FM rigs).

Only time will tell what it will take to get the IC-230 to work properly but we are on the track using ideas from the GLB literature. I wired up a variation of their circuit to attach the GLB TNC to the IC-2AT. Their circuit would have knocked the audio down to about zero so I left out a one Meg series resistor and used the circuit in Figure 1.

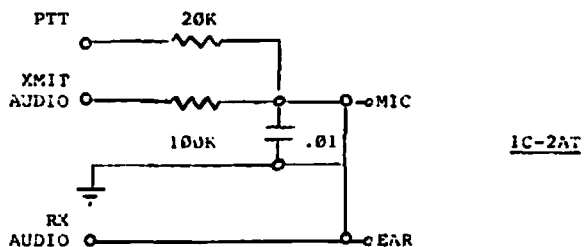

FIGURE 1. GLB TNC TO IC-2AT CONNECTION
 (continued on page 10)

(COMPARISON continued from page 9)

The IC-2AT has a nifty Push to Talk circuit that is overlooked by most interconnectors. All it takes is a little leak between the mike audio circuit and ground to key the rig. The 20K resistor provides that leak when the keying line goes low. The 100K resistor and .01 UF capacitor are GLB's idea. It took off and ran with the first transmission. Figure 2 shows the connection between the TAPR TNC and the IC-2AT. It also took off and ran with the first transmission.

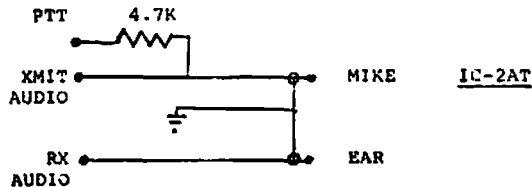

FIGURE 2. TAPR TNC TO IC-2AT CONNECTION

Connections between the TAPR TNC and the IC-22s and TS-700 were made without any additional components. The TS-700 keying line draws 170 mA and the IC-22s draws 62 mA so neither one can be keyed directly with the GLB TNC without a buffer. I think I already mentioned that the IC-230 draws 100 mA so it also would require a buffer if used with the GLB.

One additional connection available on the GLB TNC is worthy of mention. It has provisions for monitoring channel activity by checking the receiver squelch circuit. On a frequency used for voice, this feature will prevent a TNC from erupting with a blast of noise when someone is talking. This feature is unnecessary on a data channel because presence of other TNC's tones prevent crashes. For the most part, I doubt this feature will be of much use because I don't intend to leave the thing unattended on a popular voice frequency anyway and will be available to supervise its operation.

The GLB TNC lacks any visual indicators that tell what or how well it is doing while the TAPR unit has more LED (light emitting diode) indicators than it knows what to do with. It actually has a spare that can be wired as the user chooses. There are indicators for carrier detect, transmit data, keying line, reset, CW ID, two for the receive audio (one for each polarity of the waveform) and the spare (an associated driver). The one I miss most on the GLB is the carrier detect and I will probably add one to my board. The XR-2211 used as the receive signal detector, has two open collector outputs that are activated by its lock detection circuit, one a complement of the other. The GLB uses one of these outputs but does not appear to have anything connected to the other. I plan to wire the circuit in Figure 3 to this output to enable me to get an idea if the receive audio level is satisfactory.

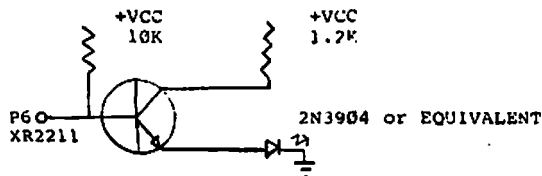

FIGURE 3. CARRIER DETECTOR MOD TO GLB TNC

Both TNCs are rich with Operator messages. Those from the GLB are rather terse, but with experience will be perfectly adequate. During a QSO it responds with numbers 1 through 6 indicating link state is:

1. Disconnected
2. Connection established
3. No acknowledge received
4. All data in buffer acknowledged
5. Other station has sent a wait request
6. Other station acknowledged wait request

Upon demand for status, the GLB will respond with a line of information containing your VADCG address (a peculiarity of that protocol), your call sign, call sign of the last station connected with, and a string of the characters and numbers indicating a whole list of status things (statii?). With a little experience, this will work quite well. For example, early in the power-up example it will show a status of "255 K5JB KB5XN 4 LDUGCE". This means it has the default VADCG address of nothing, it is K5JB's TNC and will connect with KB5XN, it is disconnected, automatic linefeed mode is enabled, status update mode is enabled, Garbage mode is enabled, Carrier back off is enabled, and terminal echo is enabled. If there had been anything in the transmit buffer, a double quote sign would have been appended to the string.

The TAPR TNC contains ability to give all this information but does it differently. It responds with a plain language message when anything changed (it should, its operating system is four times bigger). To check on status of a particular thing the operator types a key word, optionally abbreviated to three letters or less, relating to the parameter being checked. From the command mode, he types "IDT" or "IDTEXT" to see what text, if any, will be transmitted in CW instead of the station call sign. I had some fun with this on Christmas Eve by typing "IDT MERRY CHRISTMAS DE WASJGU ES K5JB" and then typing "I" to get it to send the greeting in CW. I put Charlie's call in there so at least someone else on 2-M would recognize a CW ID.

If a complete status report is needed, or one can't remember syntax of a command, he can type "DISPLAY" or "DISP" followed by an optional class code. If the class code is skipped, the whole list of 63 parameters is displayed. Using the class code reduces the information to digestable portions. For example to display link status:

```
cmd:DISP L
AX25      ON
CONMODE   CONVERS
CONOK     ON
CR        ON
DIGIPEAT  ON
FULLDUP   OFF
HBAUD     1200
LFADD     OFF
MAXFRAME  4
PACLEN    128
RETRY     10
TRACE     $1000
VDIGIPEA  OFF
VRPT      OFF
XMITOK    ON
```

Well, what's the conclusion? It is a little early to tell yet but I think the TAPR board is the real Cadillac, while the GLB appears to be a Chevrolet. Since the GLB runs on a single voltage power supply of 11 to 14 volts, it is a natural for carrying around for show and tell and portable demonstrations. I regret that the GLB won't operate in repeat mode because that is a nifty way to demonstrate or test the concept, connecting with one's self through another TNC.

There are still deposits in Tucson for three more TNC's and I wish they would hurry and get here. If anyone is planning on getting the GLB TNC (or already has one on order) I will be glad to switch the TAPR unit over to VADCG protocol to give them someone to talk to.

Vic-20 Terminal

by Jay Nugent, WB8TKL

Many people have asked if the Commodore VIC-20 or Commodore-64 can be used with the T.A.P.R. Terminal Node Controller. Further, if they can, what hardware and software would be needed to allow them to operate properly together

The answer is yes, these systems can certainly be used with the TNC. In response to the second question, I would like to present a circuit for the RS-232 interface and supply several software listings to get you started.

The TNC requires no intelligence in the terminal connected to it. Nor does it need to use the RS-232 handshake lines. Because of this simplicity, software used in the VIC can be as simple as the three lines shown here.

```
1 OPEN2,2,2,CHR$(6)
2 GETAS:IFAS><"THEN PRINT=2,AS:
3 GET=2,B$ : PRINTB$: : GOTO2
```

As you can see this program is so simple that it could be written on a gummed label and stuck to the case of the VIC for reference, eliminating the need for the cassette drive. (This is one of many ways that Tom Peeny WBKOK, has made putting on Packet Radio presentations for clubs much easier.)

The Programmers manual for the VIC has an example terminal program on page 258 that works well for half duplex systems. The host does not echo characters that you send it, rather each one entered at your keyboard is sent directly to the screen as well as to the host. This can be convenient in Transparent mode, when long delays can leave you wondering what you have typed.

Here is a simplified version of the example given in the programmers manual. The local echo can be changed by removing the B\$: in line 240.

```
10 REM *** T1700 300 BAUD 7 BIT ***
20 REM *** MARK PARITY FULL DUPLEX ***
30 REM *** FOR 3 LINE INTERFACE ***
100 OPEN2,2,3,CHR$(6+32)+CHR$(32+128)
110 GET=2,AS: REM TURN ON CHANNEL & TOSS A NULL
210 GET B$: REM GET KEYBOARD
220 IFB$<>"THEN PRINT=2,B$: REM SEND CHARACTER
230 GET=2,CS: REM RECEIVE CHARACTER
240 PRINTB$:CS: REM PRINT ALL INPUTS TO SCREEN
250 SR=ST: IF SR=0 200: REM CHECK FOR ERRORS
310 PRINT "AN ERROR HAS OCCURED"
360 IF(PEEK(37151)AND64)=1THEN360:REM ERRORRECOVER
370 CLOSE2: END
```

For a little pizzaz, such as Tape Dump and Control characters you may prefer this program.

NOTE: I have had a lot of trouble with the tape dump routine. If you make it run better I would like to hear from you.

```
10 PRINT"the clear screen character goes here"
20 PRINT"*****"
00 PRINT"*** -COMM- ***"
70 PRINT"*** FOR USE ON: ***"
80 PRINT"*** TAPR-TNC ***"
82 PRINT"*** IBM & DEC ***"
85 PRINT"*** HAYES MODEM ***"
86 PRINT"*** W/TAPE SEND ***"
87 PRINT"*** BY:WB8TKL ***"
38 PRINT"*** 830701 ***"
89 PRINT"*****"
91 PRINT"*** F1=CNTRL-S ***"
92 PRINT"*** F3=CNTRL-Q ***"
93 PRINT"*** F5=CNTRL-C ***"
94 PRINT"*** F6=CNTRL-E ***"
95 PRINT"*** F7=CNTRL-Z ***"
96 PRINT"*** F8=SENDTAPE ***"
97 PRINT"*****"
```

```
100 OPEN#130,2,3,CHR$(30)+CHR$(160)
190 REM** GET KYBD **
200 GETB$
210 IFB$=""THEN300
220 A=ASC(B$)
240 REM** CNTL TEST **
250 IFA=133THENPRINT#130,CHR$(19);:GOTO300
255 IFA=134THENPRINT#130,CHR$(17);:GOTO300
260 IFA=135THENPRINT#130,CHR$(3);:GOTO300
265 IFA=136THENPRINT#130,CHR$(26);:GOTO300
266 IFA=139THENPRINT#130,CHR$(5);:GOTO300
267 REM** TAPE CALL **
268 IFA=140THENGOTO700
269 REM** SEND BYTE **
270 PRINT#130,B$;
290 REM** RECV BYTE **
300 GET#130,CS
301 REM** DROP NUL **
302 IFC$=""THEN GOTO310
303 REM** DROP CNTRL-S **
304 REM** DROP DEL **
305 IF CS=CHR$(19)OR CS=CHR$(127) THEN300
307 REM** UPPERCASE **
308 IFASC(CS)>96ANDASCI(CS)<123(break to fit 50
column line -ed.)THENC$=CHR$(ASC(CS)-32)
309 REM** DISP BYTE **
310 PRINTC$:
300 REM** ERR CHECK **
400 SR=ST:IFSR=0THEN200
500 PRINT"ERROR":;
510 IFSRAND1THENPRINT"PARITY"
520 IFSRAND2THENPRINT"FRAME"
530 IFSRAND4THENPRINT"RECEIVER BUFFER FULL"
540 IFSRAND128THENPRINT"BREAK"
600 IFST=0AND(PEEK(37151)AND64)=1THEN600
610 CLOSE#130:END
690 REM** TAPE READ **
700 CLOSE#1:OPEN#1,1,0
720 GET#1,D$
730 IIFD$=""THEN790
750 PRINTD$:
760 PRINT#130,D$:
780 GOTO720
790 CLOSE#1
795 PRINT"TAPE END":GOTO200
```

This last program has control characters that are called by function keys. These can be easily changed to send any character.

None of the programs I have listed implement any hardware handshaking so an RS-232 interface is extremely easy to build. Of course you may use the VIC011A RS-232 adapter that is available from Commodore if you prefer.

Here is how to build your own.

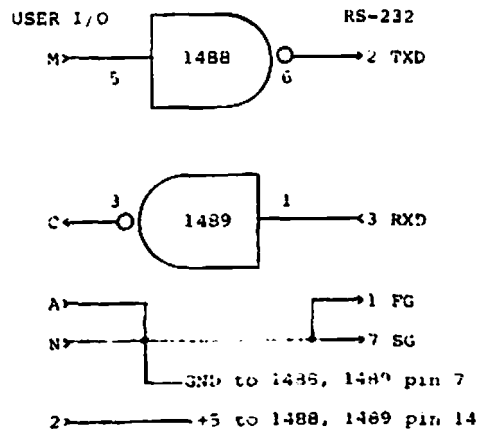

The 1488 needs a minus supply voltage. I use a 9 volt battery with its positive to ground and the negative to pin 1 of the 1488.

TNC Calibration

by Steve Goode, K9NG

Tests have shown that optimum system performance is obtained when both the transmitter and receiver are out of clipping. For the receiver this means keeping the receive LEDs OFF when a station is being received. Setting the transmitter deviation requires at least one station in a local area network to have access to an oscilloscope. That station should then follow the procedures outlined below to set all stations to the proper deviation.

NOTE: Do not adjust the deviation control in the transceiver during any of the following adjustments. Adjust only R25 on the TNC.

Calibrating Receive Deviation

1) Find the discriminator output of your receiver and connect the oscilloscope to it. This point should be before any de-emphasis circuitry.

2) Instruct the station that is going to set their deviation to remove JP11 and turn their TNC on. Have them enter the calibrate routine by typing "cal." Select option "4" to set CW null. Do not remove any jumper besides JP11. Have them hit any key and then "K" to key the transmitter. While the transmitter is on the air they should slowly increase deviation by turning R25 clockwise. Observe the tone displayed on the oscilloscope. At some point the tone level will stop increasing and may begin to distort. The peak to peak voltage where the tone stopped increasing should be noted since it is the maximum deviation before clipping. When the station stops transmitting have them slowly turn R25 counter clockwise until the peak to peak voltage is equal to the maximum clipping voltage.

3) Have the station take the jumper removed from JP11 and place it across the lower two pins of JP11 and JP10. Have them transmit again by hitting "K". This should lower the tone frequency and drop its amplitude. If the amplitude did not drop the transmitter is still in clip and R25 should be lowered until the lower frequency tone is observed to drop.

Calibrating Transmit Deviation

If only one oscilloscope is available in a LAN and that station does not have a second receiver, they may set their transmitter deviation as follows:

1) Connect the oscilloscope to the output of the transmitter audio stages. This is usually the top of the deviation control.

2) Remove JP11 and turn the TNC on and enter the calibrate routine as described above. Hit any key and then "K".

3) Observe the tone on the oscilloscope while adjusting R25 clockwise. As described above, after some time the tone level will stop increasing. This is the clipping level. Turn R25 down until the tone amplitude is just at the clipping level.

4) Take the jumper removed from JP11 and place it on the lower two pins of JP11 and JP10. The tone should decrease in frequency and amplitude. If the tone amplitude does not drop the transmitter is still in clip and R25 should be lowered.

Remove the jumper from JP10 and JP11 and replace it at JP11.

GDC Modem

by Tom Clark, W3IWI

For those of you using the General DataCom 202A modems, here are modifications and switch settings I have evolved:

(1) The piggy-back reverse channel board should be removed, it is of no use. It's I/O connector (J1) is used in the audio input mod described next.

(2) Audio input to demod: There is too much gain in the receive input circuitry. The input stages go into clipping and cause intermod problems. Disable the normal input circuitry by setting S4-1 to OFF. Now disable the equalizer by putting the jumper S3 (located near switch S1 and also labeled "EQUAL") to the IN position. Your audio input can now be applied to the reverse channel I/O connector J1. This input is now Hi-Z. Pin 6 = Gnd, Pin 5 = audio input (no connection on GDC). Put 0.1 ufd cap between pins 2 & 5 (i.e. Pin 2 is really the audio input, pin 5 is a tie-point). Therefore audio input is to TP10, directly into RX Filter at Z5. A few hundred millivolts seems to work well -- with noise (i.e. open squelch) set rcvr audio level so that the BB light on the front panel is on with an eyeball estimated 50% duty cycle.

(3) Monitor test point: For a tuning indicator in FSK use, and for "cats-eye pattern" equalization tests, add a monitor test point at the output of the demod before the data is clipped to RS2J2 levels. On the board between the "DUS-NORM-ANALOOP" switch and the LM709 ICs Z12 are four resistors. The resistor nearest Z12 is R116 (19.1 Kohms). The end of R116 nearest an 820 pf cap is TP18 (pin 12 of Z12). TP18 is the best monitor point I have found. When working AD-10, I take this to a scope triggered by received data (RS232 pin 3) to set both DC level and IC720 passband tuning.

(4) Switch & jumper settings used at W3IWI:

S1	-- not used with mod (2)
S2	-- 4 Wire
S3	-- IN
S4-1,-4	-- OFF
S4-2,-3	-- ON
S5	-- All switches OFF
S6-2	-- OFF
S6-1,-3,-4	-- ON
S7-1,-2,-3	-- OFF
S7-4	-- ON
S8	-- CH7
S9	-- All switches ON

(5) I use the TAPR boards on-board modulator, but the GDC Modulator is Fu too. TX audio is picked up on the J3 header pins 2 & 4 thru xmfr T1, or from S2 on the "2-W" pin without going thru T1. I chose to add a mike connector and crystal-can T/R relay to make xmtr interfacing cleaner. When used with my old VADCG TNC, the relay is triggered from a NE555 watchdog timer from RS232 pin 4 (RTS) and a 2N2222.

(6) I have found the easiest I/O connections are ordinary phono jacks, there is plenty of room on the back panel for them. I get the .25 inch type from Radio Shack. One GDC I modified included a VADCG TNC, an extra power supply and T/R relays all self-contained within the GDC box. It would probably be prudent to bring RX data (pin 3) and carrier detect (pin 6) out to phono jacks. A GDC interface to either a TAPR TNC or UoSAT receiver would then be easier. Also, you might want to add a DPDT reversing switch on the inputs to the RS232 data line driver (ZJ2, pins 4&5). I understand that UoSAT-B has the opposite data polarity from UoSAT-A.

PacSat Tracking

by Phil Karn, KA9Q

PACSAT, just like AO-10, will have to be tracked and its orbit continuously re-determined if it will carry an orbit changing capability. If we use the water rocket, with its very low thrust levels, we will need the ability to detect subtle changes in the orbit. I've been thinking about the best way to do this, and the following is a suggestion.

Since the Apollo program, NASA manned flights have carried something called the "unified S-band tracking and telemetry system". The ground station transmits a PM (PSK) command uplink on 2106.4 Mhz. The spacecraft tracks the uplink carrier (which may be suppressed) with a Costas loop, and synthesizes a downlink carrier at an exact ratio of 240/221 times the uplink. The nominal downlink is therefore 2287.5 Mhz, but it will contain the doppler shift of both the uplink and downlink paths. The downlink is also PSK modulated with spacecraft telemetry or voice or whatever.

Back on the ground, you can put a Costas loop on the downlink signal, extract the telemetry which is also PSK, and compare the (suppressed) carrier to the uplink frequency. This gives you the simultaneous capability to send commands, receive telemetry and determine accurate doppler information, all with just one up and down link.

I am suggesting that we put a similar capability on PACSAT. The 70cm command receiver and 2m transmitter could be arranged such that when there is no command uplink, the transmitter uses an internal crystal to determine frequency. When command lock occurs, however, the downlink frequency is determined by a synthesized ratio chosen such that the nominal uplink frequency gets turned around into the nominal downlink frequency. It would then be an easy matter on the ground to count the uplink and downlink frequencies, computing a pretty accurate doppler signature. The advantage of this scheme over simple beacon frequency measurement is that you don't have to worry about temperature drifts of conversion oscillators in the spacecraft. Everything is phase locked, up and down. There might be PLL jitter in the received carrier because of noise, but that is much more preferable over a systematic

.....
The following is a report on some interesting packet radio experiments using AO-10.

- WHGAMX appeared for his baptism under fire and showed that, despite being 2500 miles from the nearest other packet radio station, he could get his act together. Rick has now QSO'd ZLJAUX, KA6M and W3IWI. W3IWI sent WHGAMX a file of about 1.2 kbytes length with good thruput in addition to a long rtty-style ragchew.

- W3IWI also sent KA6M a total of about 9 kbytes of data plus several kbytes of rag-chewing.

- Packet SWling that weekend were ZLJAUX, KA9Q (NJ), WB9MJN (IL), N5AHD (TX) and W4KDP (AL).

- It would seem that the biggest challenge we have now is to come up with some rcvr/modem hardware that improves on the link performance achieved with FSK, and which is APC controlled to minimize tuning touchiness. Also, we now need to get some stations set up with gateway capability so that local area networks in metropolitan areas (DC, LA & SF) will probably be first) can use the satellite for inter-net ties.

Any volunteers to work on these projects?

bias because of unknown oscillator frequencies.

This could be accomplished without affecting the normal transmission of data on the downlink. Although, you might also want to implement a ranging turnaround mode with PN sequences (as in AO-10) to gather range as well as velocity data.

Doppler measurements would probably be preferable on PACSAT to the range-only measurements made on AO-10 because of PACSAT's much lower orbit and correspondingly higher velocities. My orbit refinement program can handle velocity or mixed velocity/range measurements easily. I suspect also that this system will be more reliable than PN ranging in poor S/N, since all you need to do is maintain lock on the spacecraft and ground Costas loops. As long as they are in lock (and this is fairly easily determined), the average velocity error will be nearly zero. Costas loops can stay in lock well below the level where the bit error rate for PN ranging becomes unacceptable.

The system could be arranged to require a certain code to be sent up to the satellite before the downlink frequency reference is switched over. This would prevent some malicious person from finding the command link by merely swishing a carrier around until he hears the downlink change.

As a minor side benefit, the tracking synthesizer could serve as a backup against a failure of the transmitter crystal. While I don't think we've lost one yet, crystals are statistically among the most unreliable components on a spacecraft.

There are a few other interesting topics to be found in the Shuttle writeups (IEEE Trans Comm, 11/78). They discuss the problem of false locks in Costas loops (and squaring loops too, for that matter) when the initial frequency error is more than 1/2 of the bit rate. I had suggested earlier that we solve this problem by leading each packet transmission with a burst of unmodulated carrier, and it turns out that the Shuttle systems handle the problem the same way - therefore I must have been on the right track!

.....
Excerpts of a report from Harold Price, NK6K:

Video tapes of the launch came out well. Ian got good coverage from about 6 seconds, while I was 20 seconds away (sound seconds). After launch we went to the UOSAT lab at south Vandenberg to listen in on the NASA links. There were several requests for info about UOSAT separation and health, since UOSAT separation came out of sight of NASA, no one knew the status. Interest was high, it was obvious that everyone wanted 100% out of this flight. Colin rang up Surrey and got the good news. I pushed some buttons on the console, came up on the link that had last asked for UOSAT info and said "UOSAT WTR, Surrey ground station reports separation and good telemetry on UOSAT-2", or some such official sounding words. To my surprise, the info was almost instantly relayed to another NASA feed by someone, and was announced over the PA system by someone else. Just another indication that everyone viewed UOSAT-2 as an important part of the overall project. We were treated well by all involved.

.....
Doing anything interesting with your TAPR board?
Let the rest of the world know!!
Write it up -- Send it in -- Be published

UoSAT-2 Status

by Dr. Martin Sweeting, UOSAT Program Manager

**** UOSAT-2 SPACECRAFT OPERATIONAL STATUS ****
4th March 1984 0800 gmt

Following a flawless launch on DELTA 174 from Vandenberg Air Force Base, Ca., UOSAT-2 separated from the launcher at approx 19:11 gmt over Turkey and in range of the Command Station at Surrey. A lengthy series of instructions was transmitted to the spacecraft to establish the initial operating conditions and then the s/c computer was instructed to switch the 145.825 MHz downlink on for 10 secs to check housekeeping data and ensure that outgassing of the beacon did not give rise to corona. The spacecraft responded perfectly first time and good data was received & decoded at Surrey. The 145 MHz beacon was then activated for several minutes, under computer control, and further data gathered which confirmed that the spacecraft was in very good shape. Just prior to LOS at Surrey, the computer was instructed to activate the beacon once more for a further 4 minutes and good data was received as the spacecraft disappeared over the horizon.

On orbit #2 the 145 MHz beacon was re-activated by abbreviated computer instructions and the short and long bursts of telemetry repeated - data indicated everything on the spacecraft to be entirely nominal and so the computer was instructed to keep the 145 MHz beacon active in check-summed telemetry at 1200 bps for the next 80 minutes.

The spacecraft arrived at UoS silent (as expected) at AOS on orbit #3 and the short and long bursts of telemetry data process was repeated - data again indicated the spacecraft to be entirely nominal and so the computer was instructed to activate the 145 MHz beacon for the next 10 hrs whilst the spacecraft was out of range of the Surrey station.

With all having proceeded perfectly to plan thus far, the UoS team relaxed (collapsed?) and waited for telemetry reports from around the world!

The first indications that all was not well came from the printer when Larry Kayser wanted to know why he could not hear UO-11 followed by Tele-Mail from Phil Karn etc. The UoS Command Team were 'revived' and awaited the first pass of the day, orbit #8. The spacecraft was silent (again as expected) at AOS, however repeated attempts to re-activate the 145 MHz beacon using the s/c computer failed as did direct command. Heated analysis of the situation resulted in the preliminary theory that the 'Watch-Dog' timer (a device that deactivates the 145 & 435 MHz beacons after 21 days if no commands have been detected from the ground)

.....
Last night I had a report from Darryl VK1DF who works at the Orrolal Valley Tracking Station near Canberra. Two operators believe they have copied signals from UO-8 on a number of occasions. The times are approximate because their primary task time was their work in tracking Landsat D1.

1. 4.3.84 1235 UTC No carrier but RFI detected and a questionable signal on 145.7317 Mhz ???
2. 4.3.84 2300 UTC Clean carrier on 145.825 Mhz for about the first half of pass. Locked on and measured carrier at -120dBm using 26M dish. It went raspy and RFI sounding, could only be heard for a few seconds at a time.
3. 5.3.84 1130 UTC Raspy carrier for 3 or 4 seconds at a time. Was -135dBm at point of closest approach. Graham, VK5AGR

- remember UO-9!) may have been incorrectly initialized and thus may have terminated transmissions prematurely. The 'Watch-Dog' can be reset by ground command. Reset and re-activation of the 145 MHz beacon were attempted on orbit #9. However this met with no success. Continued attempts on orbit #10 yielded nothing and things began to look rather grim. At that time no reason could be found for the premature shut-down of the beacon and the prevailing theories tended towards cataclysm. Additionally, Tele-Mail 'went down' and we had to resort to phoning around to gather more pieces of the picture! Data from G.Ratcliffe via phone from Australia confirmed that the spacecraft systems were functioning nominally when he tracked UO-11 just before termination of transmissions. The spacecraft was in very good shape!

Detailed examination of the s/c computer software used during the first few passes showed that the timing had been in error - the timing clock selected had been running at 8 times that required - resulting in premature shut-down of the beacon on both orbit #2 and #3 entirely in agreement with observations! This now veered the theories away from the 'Big Bang' and towards some sort of spacecraft systems problem.

Lack of feedback from the spacecraft keeps us effectively blind and all we can do is postulate the most likely theories based on pre-launch experience. The current theory is that there may be a problem with the 145 MHz beacon causing it to fail to operate correctly and generate wide-band noise and block the command receivers. This theory is based on observations of the performance of the beacon during test where some problems of this nature were encountered but were later believed to have been fixed. The Surrey Command Station is continuing to attempt to command the 145 MHz beacon OFF and the 435 MHz beacon ON - so far without success. If the 145 MHz beacon is ON but not operating correctly, it should be possible to observe it with high gain antennas and spectrum analysers etc. Should this prove to be the case, then it may be most profitable to attempt to command the spacecraft using the 1.2 GHz command uplink as this uplink is the most independent of the VHF/UHF systems.

All we can do is try out various theories - we tend not to favour total system failure or spontaneous detonation at present rather some more limited scenario. We shall keep you posted as to our thoughts and progress. Needless to say, everyone here is somewhat disappointed after the efforts of the last months and such a flawless start to UO-11's life! We still have faith, though!

.....
The current plan is to try some high power commanding from the West Coast. We will put 150kw ERP into the 1.2 GHz receiver sometime this week. At that high power level our beam width is only 6 degrees so we will pick a part of the sky and blast away at it. As Phil points out, even though we are unsure of the elements, all pieces of the delta 174 launch will pass thru the same point. Although now they are spread out over 6 to 8 minutes in time along the path. We also have a lower gain antenna at the 15kw level that we can use for tracking of the spacecraft. If the 1.2 GHz doesn't work, then we'll try high power on 2 Meters and 70 CM

Harold, NK6K

Big Ears

by Jay Holladay, W6EJJ

Harold Price contacted me this afternoon (Saturday) and requested help with getting one or more well-equipped moonbounce stations on the west coast to look for signals from UO-11. I started with Lance Collister, W4LJXN, in Frenchtown, Montana, and he put me in touch with K6MYC and W5UN. We were fortunate to have all three stations operational and available to help with the search tonight. That's the good news.

The bad news is that none of them heard any signals from UO-11. These are three of the best-equipped moonbounce stations in the West, and if none of them could hear a signal, there was probably no signal to be heard.

Locations and antenna setups

- W4LJXN
Frenchtown, MT - 12 X 19-element Boomers
- W5UN
Midland, TX - 16 modified Quagis/26 ft booms
- K6MYC
San Martin, CA - 8 long yagis/28 ft booms

All stations are using good GASFET preamps located at the antenna. Predictions were run by W6PAJ using UO-11 element set NO. 4. W5UN also ran some using the same element set. The following shows the times of the passes that were checked and predicted maximum elevations.

4 March UTC

- W4LJXN 0300-0311Z -- 14 deg
0436-0449Z -- 79 deg
- W5UN 0255-0316Z -- 17 deg
0431-0444Z -- 38 deg
- K6MYC 0434-0446Z -- 33 deg

So, we gave it a good shot and the results are not encouraging. Each station agreed to try one good pass tomorrow morning in hopes that being in sunlight will coax some signal out of the satellite. They will call me if any signals are heard, and I will notify Harold right away.

We owe each of these operators a big "thank you" for responding quickly and well to our request for help. It was a pleasure to work with them.

Here's hoping contact can be re-established with UO-11. 73.

Note from W3IWI--

Attempts to hear using stations with "big" ears (K1WHS, W4DFK), on the east coast have proven negative thru Sat. Nite. Sun. AM attempts at W3IWI (within abt 2 dB of EME capability) have also proven negative.

Effective Rates of Communication

- CW 13 - 20 WPM RTTY 60 - 100 WPM
- AMTOR <100 WPM VOICE 100 WPM
- VADCG/TAPR -- 1000 WPM
- Specialized Packet Systems -- 1,000,000 WPM +

Uo-B Telemetry

by Phil Karn

The last reported UO-11 frames are from Graham Radcliff in Australia. The last frame he sent me on Telemail was at about 23:15 UTC; this is about 45 minutes before the no-show at KA9Q. The path of the satellite between these two times took it over Antarctica and up the Atlantic Ocean. There was visibility in most of eastern South America, Falkland and Ascension Islands. In particular, Falkland's pass included the start of the half-hour eclipse which occurs on each orbit. Anybody know anyone down there?

I've written a telemetry decoding program in "C" for anyone who wants it. Harold has a copy and he's bringing it up on his system. From my examination of Graham's frames, nothing really looks suspicious. Rather than post it here (the decoded version of his frames is 116K!), I'll give a summary.

Temperatures were running cool, but not exceptionally so for a spacecraft, but remember it had been in sunlight for a while and was about to enter eclipse in about 20 minutes.

The battery was sitting at a stable +6 C, the battery voltage at a little over +14 with little fluctuations, and all the solar arrays were producing power (but not at the same time, of course). The battery charge/discharge current was fluctuating rapidly, sometimes going slightly negative but usually running at a few hundred mA positive. The spacecraft was obviously spinning fairly fast as indicated by the rapidly changing solar array and battery currents.

Regulated voltages looked reasonable. From a phone conversation with Harold, none of the various currents seemed out of line. The warmest temperature reading was, of course, the 2m beacon: +16.6C. It was putting out about 650 mw of RF.

Facet temperatures were cool, ranging from -5C to 0C, except the -Y facet with a consistent warm reading of +12.8C.

The mode bits were as expected, 1502 computer, nav mag and 2m beacon about the only things turned on. The navigation magnetometer seemed to be producing numbers. No activity was seen on any of the command receivers (but they were drawing supply current). The computer was on, but not commanding the spacecraft. The command watchdog timer was enabled; according to Harold, this timer runs for about 20 days and turns off the beacons if no command is heard from the ground in this time.

I'm stumped.

Broadly, UOB is designed to support three downlinks at 145.025 MHz, 435.025 MHz and 2401.0 MHz (not all necessarily at once!). The 145 downlink will support 1200, 600, 300 & 150 bps ASCII data A.F.S.K. (1200Hz & 2400 Hz data synchronous) as per UOSAT-1. The 435 and 2401 downlinks will support 1200, 600, 300, 150 bps synchronous AFSK (1200 Hz & 2400 Hz) and 2400, 4800 and 9600 bps synchronous AFSK using data rate and twice data rate AF tones up to 19.2 kHz! These two downlinks also will support up to 9600 PSK (+- 90 degs) NRZI encoded.

We are currently examining the possibility of also providing a second PSK option where the clock is logically combined with the NRZI data. All the data on the spacecraft is generated and sent in an asynchronous manner. UOSAT-B is intended to provide a test bed for various transmission formats to assess their relative performance.

by Harold Price, NK6K

PACSAT hopes to launch via a get away special, so what better way to get some experience with a GAS than to do a simple one first. Following is the text of an announcement concerning AMSAT's participation in a GAS experiment. Thanks go to Phil Karn who originally spotted this opportunity in one of the many electronic BBS he reads.

February 10, 1984

AMSAT has agreed to supply the primary controller for a Space Shuttle "Get Away Special" experiment package. The GAS package, with 12 experiments mostly in the Biological sciences, is a community sponsored project in the Texas cities of El Paso and Ysleta.

The experiment is the primary GAS package on STS 41-F, currently scheduled for launch August 9, 1984. This mission will be the second flight for Discovery, the third orbiter in America's shuttle fleet.

The GAS experiment slot was originally obtained by the local Coors Beer distributor in 1977. The experiments are being designed and built by El Paso/Ysleta high school students. Technical advisors have been supplied by the local Gas and Electric companies. Funds and other support have been obtained from community members.

When the original supplier of the controller backed out of the project, El Paso/Ysleta put out a general call for help. AMSAT accepted the challenge of designing and building the required hardware in the few months remaining. The basic requirements of the controller match the requirements of the PACSAT low power portable ground station controller. A team within AMSAT had already been formed to do that design, and the group had forward momentum built up from work on the Digital Communications Experiment, which will fly as part of the University of Surrey's UOSAT-B satellite on March 1, 1984.

The controller will monitor and record the temperature in each of the 12 experiment compartments. The temperature will be controlled in some areas by switching a heater on and off. Several experiments require movements of an actuator, controlled by a stepper motor.

Although the GAS experiment does not relate directly to amateur radio, AMSAT will gain experience with the shuttle and the GAS program, requirements for the PACSAT project which hopes to deploy from a GAS can in 1986. The controller design will be used for the low power portable PACSAT ground stations required by VITA, co-sponsor of the PACSAT project. Funding for the GAS controller will be supplied by the El Paso/Ysleta group.

The GAS controller will be implemented under the auspices of AMSAT's PACSAT project. Lyle Johnson, WA7GXD, is the group leader for the controller project. Much of the work will be done by Bill Reed, WD0ETZ, manager of PACSAT ground station design, and his group in Dallas. Chuck Green, N0ADI in Tucson will be involved in system design. Harold Price, NK6K will coordinate software activities.

TAPR MEMBERSHIP

Nov. 1981 - 6	Feb. 1983 - 250
Feb. 1982 - 35	Feb. 1984 - 650
Jun. 1982 - 100	Feb. 1985 - 777

by Hank Magnuski, KA6M

On Sunday, March 11th, on orbit 560 of AMSAT/Oscar 10, KA6M in conjunction with the following stations, successfully demonstrated the interconnection of two packet radio stations with intermediate links using a terrestrial packet repeater and two AO-10 groundstations. This is probably the first all digital interlink experiment performed on the AMICON channel.

Tom Clark W3IWI Clarksville, MD
(Washington, DC area)

Hank Magnuski KA6M Menlo Park, CA
(San Francisco area)

Harold Price NK6K Redondo Beach, CA
(Los Angeles area)

Jim Titteler A18A/6 Los Gatos, CA
(San Francisco area)

Ron McMurdy WA0OJS/6 Monterey, CA
(San Francisco area)

The first contact at 19:00 UTC was between W3IWI and WA0OJS. Tom was working with a very low-on-the-horizon pass, had limited time, and so only a short fragment of text made it in both directions. About an hour later, at 20:05, NK6K successfully chatted with A18A for about ten to fifteen minutes, in what almost seemed like a local QSO. In both connections the intermediate links looked like this:

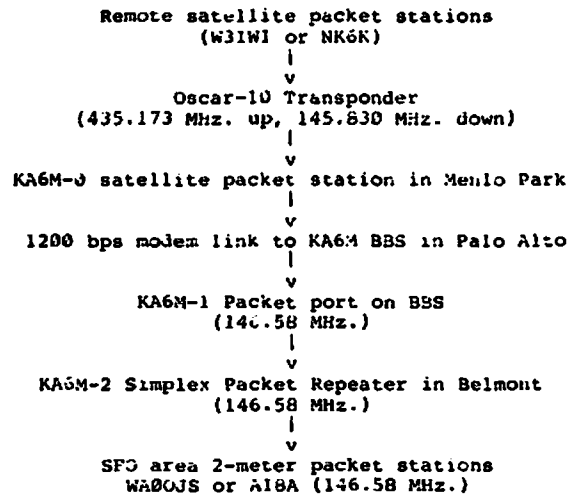

On both contacts text was transmitted in both directions. Error-checked AX.25 connections were maintained between the two satellite stations and between the computer's packet port and the outlying users. However, over the modem link only text was transmitted, and no packet protocol was employed. Equipment included a mixture of TAPR and VADCG terminal node controllers. A total of five TNCs had to be properly connected for all this to work.

Not suspecting that anything special was going on, Ron and Jim connected to the computer system expecting to pick up their mail. Instead, they found that they were connected directly to stations in remote geographic areas, and the packets they were getting were coming from outer space. No one was more surprised than I was when the first text started to come through.

Hopefully, it won't be too long before this kind of operation becomes routine.

Board Minutes

04 February 1984

Directors present:

Mark Baker	Chuck Green	Mike Parker
Mike Brock	Lyle Johnson	Marold Price
Den Connors	Dan Morrison	Bill Reed
Peter Eaton	Margaret Morrison	Pat Snyder

Directors absent:

Marc Chamberlin Tom Clark Dave Henderson

The meeting was opened at 8:20 PM by Lyle Johnson, President.

ELECTION OF OFFICERS

The first order of business was election of Officers for a one year term.

Lyle Johnson was elected President, Peter Eaton was elected Executive Vice President, Heather Johnson was elected Secretary, and Chuck Green was elected Treasurer.

OLD BUSINESS

Motion was made to dispense with the reading of the minutes of the last Board meeting. The motion was seconded and carried.

The Treasurer gave a description of TAPR's financial position and growth of the organization in general.

1982 income totaled \$33,501.

1983 income totaled \$72,743.

January 1984 income totaled \$41,202.

As of 31 December 1983, TAPR's assets totalled \$16,236 against liabilities of \$14,320, for a net of just under \$2,000.

TAPR had distributed

12 Alpha kits
172 Beta boards
380 TNC kits
as of 4 February 1984. He projected a total of 2,000 kits by February of 1985.

TAPR's membership had grown

6 in November, 1981
35 in February, 1982
100 in June, 1982
250 in February, 1983
650 by February, 1984

Due to use of an outside commercial firm for kit packaging, the shipping and handling charge for US shipments will increase from \$7 to \$10 per TNC as of 1 March 1984.

An order form will be supplied for publication in PSR, giving pricing on all TAPR services.

TAPR will refrain from borrowing money directly, although Modular Mining Systems (MMS) is fronting money for TNC kits at the rate of \$10,000 to \$20,000 per month plus donating a portion of Lyle's worktime to coordinate parts flow. MMS indicated a willingness to continue to

support TAPR in this manner, and the Board expressed its appreciation of MMS' generosity.

Another form of "loan" that TAPR has used is the advance deposits received against TNC kits. During late 1983 through February 1984 this has amounted to two or three months' use of the deposit monies, but the deposits are carried on the books as a liability. This sort of money-in-advance carried TAPR through 1983, and each kit sale helps get us further out of the hole. There is an estimated \$10,000 tied up in kits ordered.

The kit documents are ordered for several months at a time, and kits are paid for in full prior to shipment.

Cancellations of kit orders have been running at about 1%. While TAPR is not obligated to refund these deposits, we have been doing so. There has only been one check cancelled on us.

Asked if the Treasurer needed paid assistance in executing the tasks of the office, Chuck indicated that he was spending one evening a week on checks plus one evening a month balancing the books. The Arizona "IRS" sent TAPR a notice requiring tax payments on a once-a-year basis rather than monthly as it had been in the past. Chuck intends to give the President a monthly financial report. An accounting firm is used for annual reports to the various government agencies, but not on a regular monthly basis.

It was pointed out that the Secretary's office was overloaded and that Heather and Lyle were "snowed" in membership support activities. An outside firm has been retained to handle most of the mailing-related activities and this was expected to reduce the Secretary's workload significantly.

It was stated that a hobby should be fun and routine tasks should be off-loaded; however, it was indicated that to date, TAPR had not been in a position to pay anyone anything.

It was noted that while the newly attained IRS tax-exempt status applied to Federal taxes only, TAPR is also Arizona tax exempt.

The issue of paid assistance was further discussed. Packet-It was the first organization retained by TAPR and this company does the kit packaging; TAPR sought help because the workload was "burning out" the Tucson volunteers and the activity was a major imposition on MMS. Packet-It was awarded the business on the basis of a competitive bid.

It was projected that, if current trends continue, TAPR may have between \$40,000 and \$70,000 income during calendar 1984 that can be directed to research and development for packet radio, information dissemination, hamfest presentations and other chartered activities.

(continued on page 18)

(Minutes continued from page 17)

The officers reported that TAPR has made available an OEM package for the TNC kit. The package is intended for commercial interests, offered on a non-exclusive basis. The package consists of art work for the PC board, source code for the software, and the manual in ASCII text on diskette(s). In order to obtain the OEM kit, the prospective purchaser must execute a letter of understanding (a copy of which will be mailed to all directors). The purchaser assumes all liabilities, marks his end product indelibly giving credit to TAPR for the portions of their product using TAPR-developed circuits/software/text, removes the TAPR logo from the PC board and agrees to not distribute the contents of the OEM package to others.

Discussion followed. The OEM package is designed to act as a filter to prevent anyone from doing a "chinese copy" of low quality with TAPR's name on it.

There was confusion in the balloting for Directors today. Two ballots were discovered after the meeting that had been handed in but somehow not counted. They changed Lynn Taylor's one-vote edge over Pat Snyder to a one-vote edge for Pat.

The issue of affiliation was raised. After lengthy discussion, it was moved that:

"any club that has greater than 50% of its membership as TAPR members may become an affiliated group and submit items to PSR for publication. Each affiliated club shall provide a liason."

The motion was seconded and carried. Part of the intent of the affiliation provision is to help TAPR provide a means of technical and organizational field support.

CURRENT BUSINESS

TNC sales are projected at about 1500 more units by the end of this year. Advertising in 73 and Ham Radio costs \$220/month, QST is twice as expensive.

(Iowa SBS continued from page 4)

OPTIONS AND TIMERS - Certain system options and timers will be under SYSOP control with selections stored in a disk file for easy system restoration. These choices will be made when the system is initially installed and changed, as necessary, to fine-tune its operation.

- * SET SYSTEM REALTIME CLOCK
- * TWO-LEVEL ACCESS: Yes or no
- * READ MESSAGE AUTO-DELETE: nn hours
- * UNREAD MESSAGE AUTO-DELETE: nn days
- * GENERAL BULLETIN DELETE: nn days

HOUSEKEEPING - This system will use the disk directory to store individual messages and bulletins. Capacity should be adequate for most Local Area Network (LAN) operations if the auto-delete feature is used correctly. However, occasional heavy use may cause system congestion requiring the SYSOP to eliminate bulletins or unread messages before auto-delete timers expire.

KSR TERMINAL - The SYSOP will be able to use the CBBS hardware as a KSR terminal to communicate with the LAN via the TNC. This feature, when invoked, will shut down the CBBS system and automatically post a beacon which indicates the system is down. This mode will also be used for the SYSOP to control various TNC options.

TAPR will be at Dayton with a booth and hopes to have 100 kits to sell over the counter there, after existing orders are filled.

A portable demo packet system needs to be assembled for Hamfest use.

Beta upgrade kits must be made available as soon as possible; the price will be determined.

EPROM programmers will sell for \$95 plus \$7 shipping and handling and will be made available as soon as possible.

The Cabinet kit will sell for about \$70; it is currently in manufacturing.

Linking/Routing is very important to the growth of packet radio. TAPR will be represented at Trenton to get inputs from other groups; TAPR historically is a group that implements.

It was decided that reimbursement for a Director's attendance to the annual Board meeting was not to be provided by TAPR; it is part of a Director's responsibility in accepting the position.

A motion was made:

"If the President deems it necessary to send individuals to a function requiring TAPR's presence, then the President is empowered to authorize reimbursement of reasonable expenses."

The motion was seconded and carried.

The subject of TAPR's relationship to outside commercial interests was raised; TAPR has no employees and can not enter into contracts for custom hardware or software.

The subject of donations was raised. It was decided that gifts must be evaluated on a case-by-case basis and should be encouraged.

The meeting officially adjourned at 12:07 am (Sunday, 5 February 1984). Informal discussions continued afterward.

by Jay Nugent, WB8TKL

I attended the quarterly meeting of the Michigan Area Repeater Council and together with John Hackman, WB4VVA, the Councils Frequency Coordinator we agreed on six channels to protect for packet radio communications in the two meter band.

They are as follows:

147.525	147.555	147.585
--	--	--
144.910	144.930	144.950

These frequencies were selected on the basis that they are rarely used in the state, the existence of the Ann Arbor digipeater on 147.555, and that these frequencies can easily be added to existing voice repeater installation antenna systems with the addition of a couple cavities without interference.

I understand that John Hackman, WB4VVA, is also a TAPR member. Noting in the records that he is the Repeater Council Frequency Coordinator may be helpful in the future when nationwide coordinations are needed to protect a network channel.

ACKnowledgements

I thought I would write a note to you describing the activities on Packet Radio here in New England. I am President of the New England Packet Radio Association (NEPRA), with members in Massachusetts, Rhode Island, New Hampshire, and Vermont. We have over 60 members in the organization, with 22 members presently active on packet. At least 10 more should be on the air within a couple of months.

We have several stations in good locations with TAPR boards being used as Digipeaters. The club is presently working on the design of inter-city networking, designing new Line Management Units (LMUs) to implement Level-3 functionality. We expect to have Eastern Massachusetts, New Hampshire, and Rhode Island linked to Albany and Schenectady, New York as well as Newington, Conn. within a few months. Some of our members are involved in different individual projects, including design of 9600 baud 220 MHz systems, S-100 bus TNCs (now partially operational), Meteor Scatter communications via Packet, H.F. Packet radio and the implementation of Bulletin Board Systems.

The BBS is my primary interest. I expect that Packet Radio activity will increase only if computers are made available via RF links. I believe very inexpensive Bulletin Board Systems should be set up in every metropolitan area to foster Packet Radio interest.

I presently have a BBS on the air, using a Texas Instruments TI-99/4A computer system. I have 48K of memory, 1 disk drive, 2 RS-232 ports and 1 (unused) parallel port. It has a mailbox feature, as well as several canned files with ARRL Bulletins, club news, etc. This entire system could be put on the air for \$500, exclusive of TNC and the radio. Of course, this system is becoming unavailable as TI is now out of the low-cost computer business. If I were to do it all over again, I would probably use a Commodore 64 with 1 disk drive, again under \$500.

If anyone has a TI system running on packet, I would be glad to share my software. I expect it could easily be converted to Commodore, Radio Shack Color Computer, etc. It is entirely in BASIC. If you think any of this would be worth publishing in the PSK, please feel free to do so. I would contribute assistance to any Bulletin Board effort.

I can be reached at home at (617) 663-9306 or at work at (617) 895-3683.

73,
Dick Eastman, K1QJH
45 Chelmsford Road
North Billerica
Massachusetts 01862

.....
I am very grateful for the opportunity to evaluate serial number 205 of the first production TNC kits. Before I begin to tell you all the things that you have done wrong, let me praise the tremendous job that you and all of TAPR have done. I have built over 18 Heathkits, 10 miscellaneous other computer related kits and well over 200 homebrew projects from minor to major in magnitude. This kit represents one of the finest units available to amateurs and hobbyists that I have ever seen. The only other things close were Heathkits. To think that this project was pulled off at no profit to the participants is totally beyond belief. Commercial Amateur equipment (and kit) manufacturers should hang their heads in shame. The software effort is also to be heartily congratulated. In the next few years I am sure

that TAPR will be seen as the single major force in the promotion of Amateur Packet Radio and the adoption of AX.25 as the standard protocol.

Congratulations and thanks.

Now down to the dirty work. The following items are the stumbling blocks which I came across:

An initial checkout beyond measuring the power supplies should be included at the end of the assembly instructions. Just tell the builder to check the jumper configuration and how to get a logon out of the TNC.

The calibration routines although adequate, would be much easier to use if the routine looped measuring the frequencies and displaying them rather than using the cut and try method implemented.

The serial port although much better than the Beta version is still not quite right. A DCE should generate DCD, not read it. This signal cannot be derived from the 6551 UART because UARTs are usually intended to be used in DTEs. It may instead be derived from the carrier detect logic which is present on the board. While this signal does not usually cause a fatal problem I would hate to see you miss perfection on such a small point.

The RS-232 signal names used in the documentation and schematic are not correct. The signal names do not change from DTE to DCE. They are all named from the DTE point of view, this includes the transmit data and received data. The correct names are given below:

pin #1 = FG	pin #6 = DSR
pin #2 = TxD	pin #7 = SG
pin #3 = RxD	pin #8 = DCD
pin #4 = RTS	pin #20 = DTR
pin #5 = CTS	

The PROM checksum should be calculated and checked each time at power-up. It seems rather silly to have a human look something up which is right at the microprocessor's finger tips. Also people are not going to bother to do it and may not realize that they have problems. PROMs do forget from time to time.

In case anyone is interested it took me about 8 hours to build and calibrate the board. I did miss one solder joint on a chip socket, my problem not yours, it took me about 5 minutes to find. I also checked the frequencies with a counter after using the built in alignment software, they were within 2 Hz, not bad.

I was very impressed by the 8K x 8 static RAMs (6264s). We don't even use those here at WAF yet. Pretty professional for a bunch of Amateurs.

Sincerely yours,
Gary Field, WA1GRC
5 Pluff Ave.
No. Reading, MA
01864

since we haven't had much luck on the Sunday net it might be worthwhile for me to update you on activity in the Colorado Springs area.

All Beta boards are up and running regularly. We have had our random glitches, though. W0YNE and W0DFHG (using the N0ENJ board) have both had some intermittent problems. The symptoms seem to be the sort generated by bad solder joints or cracks in the board. W0DFHG seems to have solved his problem. W0YNE is in the process of resoldering.

We are in twice weekly net contact with a group of 3 VADCG boards in the Denver/Boulder area. They just got their Magnuski software. One of them (W0B1QN) is also getting a TAPR kit.

At a large hamfest in Boulder we had all five of the Beta boards involved. Two of them at the hamfest, two in Colorado Springs in operation as a standard TNC and bulletin board, and one as a mobile digipeater on Pikes Peak linking us all together. The VADCG boards did not have their new software then but we had one on display at the hamfest anyway.

When John (W0DFHG) got his kit, several of us went over to "help him" unpack it. We were all pretty impressed. You may have his report by the time you get this. He put it together on Saturday and on Sunday AM I stood by for it to emit its first packet. He told me on voice that he was going to send a connect. Only one short packet came through. Then I looked at my screen and it said ***CONNECTED TO W0DFHG. I am duly impressed and looking forward to putting mine together.

When I get my kit operating we will install my Beta board on Pikes Peak or co-located with one of the higher Denver repeater sites. Wherever we can get the best coverage.

Pete made a comment in the SLAPER newsletter that packet elicits more interest from computerists than it does from hams. That has been my observation here too. The Oklahoma telephone modem flap isn't going unnoticed by these folks either. By the way, Colorado has the same PUC rule. As a matter of interest, the CP/M SIG of the Denver Computer Society has asked to have our presentation and demo for their entire 3 hour meeting on 10 November. That says something! Of course it stands to reason that the greatest advocates of packet radio will be those that can use it most efficiently. Computerists have a built-in requirement for high speed, high volume data transmission right now. The average "QSO JOE" does not.

I hope that someday the Amateur community will recognize the great contributions you folks have made. When that time does come the recognition will, no doubt, be for your great technical contribution. And, since this IS a hobby, maybe that is proper. But I, personally, want to express my appreciation for your dedication to seeing it through, for the countless hours of work, for the frustrations, and those many, many personal sacrifices that we, as TAPR TNC users, will never know of. There are many in the effort whom I have never met nor talked to. The foregoing comments are just as sincerely directed to them.

I still remain available for any non-technical tasks that I might be able to accomplish from a remote location so please do not hesitate to ask. Hope to see you in February.

73

Andy, N0CCZ
5222 Borrego Drive
Colorado Springs
Colorado 80918

The continuing saga of the TNC vs. the TRS-80 Model 100 goes on. The information contained in the latest issue of the PSR is incorrect. The M-100 does indeed generate an RS-232C compatible signal but the voltages available to the RS-232 driver in the M-100 are only +/- 5V. If the TXD line is unloaded, a proper bipolar signal is generated. There is a problem, however, because the M-100 has the following output network:

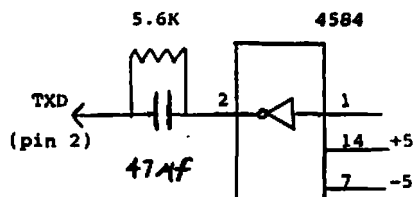

If you do the calculations based on the internal network in the 1489 receiver and the outboard 6.8K resistor you realize that the input impedance of the RS-232 network of the TNC is on the low side of the EIA specification.

To make a long story short, just remove R4. Proper operation cannot be guaranteed if there is any pull-up/down resistor external to the 1489. There is already a pull-down resistor (to ground) in the 1489 so R4 is superfluous. Is anyone likely to operate their TNC disconnected from a terminal? In any case, the TNC works very well if R4 is gone.

Bugs:

Well, I didn't get the nickname "Mr. Orkin" for nothing. I have discovered the following bugs in the 3.0 software:

1. After much shifting from transparent to converse modes, the TNC would no longer echo <CR><LF> to the screen when <CR> was sent from the terminal. Soft reset (the RESET command) did not cure the problem. A hard reset (switch bit 3) was required. Other functions were normal and <CR> continued to be the SENDPAC character.
2. Eight data bits with no parity can not be selected.
3. Setting the beacon with 'BEACON EVERY n' and PERMING the state of the machine causes 'BEACON EVERY n' to be set and displayed, but the user must reissue the BEACON command to start the beacon again after a reset, either soft or hard.
4. My ABAUD value is always set to 19,200 every time I power up the system. This DOES not appear to be a problem with the NOVERAM but I could be mistaken. Perhaps a check with TAPR would be in order.

Other than this, I am amazed at how reliable the TNC software is! This is truly a great piece of engineering.

Activity in the Pacific Northwest:

We are very active on packet here in the Pacific Northwest (a region running along Puget Sound from Olympia, WA, to Vancouver, BC). At current count we have 10 operating stations with about 10 more on the way (under construction or ordered). Most packet activity is on 146.55 simplex but a new data repeater on 145.25 has been installed and packets have been exchanged successfully. This repeater has an audio passband from about 1Khz to 3Khz so the standard modem/TU tones can pass but voice operation is discouraged.

(continued on page 21)

(BRIAN continued from page 20)

We are going to begin discussion of linking Vancouver with Seattle on Saturday, Jan. 21. I will pass along whatever comes of this meeting.

Much of the rapid growth of packet here in Washington has come about due to the activity of our local VHF RTTY repeater. Most of the people who operate RTTY up here have computers and the step to packet was a small one. The heavy usage of the RTTY repeater led to a search for a more selective means of transferring information. Traffic on the RTTY repeater is up to about 80,000 characters per day and that is a lot of reading for many people. Packet radio is perceived as the answer to the problem.

Interfacing the TR-2500 handheld to the TAPR TNC:

I have just recently connected my TR-2500 HT to my TNC and have been pleased with the performance. The 2500 uses a miniature phone plug for the mic audio in and a sub-miniature phone plug for the external speaker out. The TR-2500 is keyed by connecting together the "grounds" or ring connections of the two plugs. The hookup is as follows:

TNC audio in.....SM Tip
TNC Ground.....SM Ring
TNC audio out.....M tip
TNC PTT out.....M Ring

(where SM is the sub-miniature plug and M is the miniature plug) The keying current for the HT is 300 microamps.

The only problem discovered so far is that RF from the HT gets into the PPT keying circuit of the TNC and prevents the HT from unkeying at the end of the transmission. Low power operation or using an external antenna solves the problem.

That is it from this corner of the world. If anyone wishes to get in touch with us, the people to contact are:

Brian Lloyd, WB6RQW (myself)
9720 79th St SW
Tacoma, WA 98498
(206) 581-2688

-or-

John Kelley, W7KKN
3119 North 32nd
Tacoma, WA 98407
(206) 759-6747

First of all, I would like to say that the kit was packed very well over all. There was lots of padding and everything was in good shape despite the large "crushed" area on one corner.

After opening the box, reading the cover letter, and giving everything a once over, I started at page one of the assembly instructions.

The inventory went well and I loved the small envelopes with the items broken down as they were.

NOTE On page F-46 of the assembly instructions, the way you show the connector and state the way the pins are labeled is just the opposite from the way MOLEX has it 'embossed' on the plastic on the face of the connector. Someone looking at the connector and not fully following the directions, could 'smoke' his TNC!!

Now for the brief info on the power-up and cal portion. It worked just as the book said. No problems with getting the board calibrated and on the air. I'm using a ICOM IC-255A and the interfacing to the mike plug is the same as the IC-22U. I did go through the back of the radio, through the accessory plug but I had that set up that way for RTTY and my TE-64 PL module with some extra jumpers in unused pins.

Once up and running I made contact with WBGUUT, Lynn, a BETA Test site in Laguna Beach, and checked out the board in practice. No problems as yet. I'll be testing the rest of the board in the next few days and weeks as soon as I get a better path to San Diego and nothing to the north to L.A. until the Digipeater goes up on Santiago Peak. I've a four element beam I'm going to aim at San Diego for now.

Should anyone be having problems getting their board up or doesn't have the time to do the work, I am offering my services, for a slight fee, to do the work for them. I've already received two requests for such assistance and I love to build things.

I would like to know more about this TNC cabinet that is mentioned in the assembly portion of the manual. Is it available now? and for how much?

Well, I think that just about covers it.

73,
Dave Hartman, KA6A10
28911 De La Luna
Mission Viejo, CA
92692

(This last one arrived here at PSR via MCI Mail. That's really using digital communication to get the job done. Someday we will forward it on to all of you via packet too, only using Amateur packet nets instead of the commercial ones. ED)

Greetings from Wisconsin:

Packet radio is alive and well in South Eastern Wisconsin. Matter of fact, we sometimes wonder who is on and who is not. To make things easier to find out who has their systems up and running we have taken to using an old TTY or Telex trick. Some of you old timers may remember that teletype machines used to have a key marked "WRU" on the keyboard. The WRU key stood for "who are you". In fact, this was a control E key which when used by a calling teletype station caused the answering station to do an "answerback". Many of the better terminal programs respond the same way on today's Micro-computer systems. So if yours works the same way, program your answerback acknowledgement with your call and QTH. Then if you have your TNC in Conversation mode and someone sends a control E, your station will automatically respond with your call and QTH. This will occur even if your not connected to anyone. A note of caution though: multiple carrier collisions are possible because there is no acknowledgement from the requesting station of receipt of answerback. As a suggestion, this may be implemented in future TNC software on a more sophisticated basis. The alternative to this is to manually call stations to verify their on-air status or wait for their beacon. The Packet radio systems here are certainly being used and are working just fine. We appreciate all the effort given toward the project.

Rees Roberts
K9UUT

HF Links

by Gary Kaatz, W9TD

Successful 300 baud packet QSOs have been held on HF after several marginal attempts. The big thrill of the first QSO took place on 7086 KHz at about 1215 CST on December 22, 1983. The rig on my end was not cooperating. The modem carrier detect was falsing on foreign broadcast heterodynes so badly it kept my transmitter from sending. Consequently Ralph had many retries while I had to ride the volume, to thwart the carrier detect, so I could ACK his packets. About eighteen packets were exchanged over the course of a half hour.

For these tests, modem tones from the TNC were sent as audio to a SSB transmitter on lower sideband. The TNC parameters were:

HBAUD = 300
TXDELAY = 10
PACLEN = 64

The only modification to the TNC was the installation of the header designed for a flat MF-10 filter response. Four things were learned from this attempt:

- A) Disable VOX, "hang" will cause missed ACKs
- B) To prevent distortion, don't modulate to full CW output
- C) SSB filters are too wide, heterodynes false carrier detect
- D) Tuning is difficult, even with 1000 Hz shift

The next tests were on 30 meters on about 10.140 MHz. This band was chosen for its low activity (no contests), lack of broadcast stations and possibly better signal conditions for linking in the midwest. We were still using the same set-ups. I had disabled my VOX and there were no heterodynes to false the carrier detect. At about 1430 CST on February 4, after receiving some of his beacons, I connected to Ralph only to find him not present!

Real success was obtained February 11. We had nearly an hour long QSO on 10.141 MHz that went so smoothly it seemed like VHF operation. He even sent me a 34 line file, with every packet received the first time. For this test the modems were modified to TAPR specs for 200 Hz shift, 300 baud operation. The flat response header for the MF-10 was retained. Ralph was able to make these changes on DIP headers in the modem area of his Rev. II kit. I used an external XR2211 - 2206 modem circuit, with no MF-10. A 400 Hz CW filter in the receiver provided bandlimiting.

The only problem encountered was difficulty tuning signals. Packets are so short they leave little time to "tweak" the receiver. I used a combination of receiver S-meter, for coarse tuning, and a voltmeter at pin 11 of the 2211, for fine tuning. Ralph tuned entirely by ear, using his own tones as a reference. He also used the DCD LED for feedback, trying to keep it lit the duration of the received packet.

The next day, Sunday the 12th, after the Mid-States Packet Radio Net, Ralph connected with Bob (WB4APR) using 200 Hz shift. Ralph's signal was too weak to copy, while Bob's was quite strong. After they disconnected, I connected to Bob and had a 25 minute QSO with him. He used a VADCG board with AX.25 software and a modified Vadic 103 modem (same tones in both directions). Two changes were necessary at this location to accommodate him. First, I set my caps lock on. Second I set the parameter LFADD to ON, as VADCG AX.25 does not automatically append a line feed to each

carriage return as TAPR software does. After we disconnected, Bob reconnected to Ralph. But due to poor conditions they encountered many retries, so the QSO only lasted a few minutes.

Stay tuned for more information on HF packeting and come down and join us!

.....
(The following are two notes received from Ralph Wallio (W0RPK) highlighting the Des Moines end of the HF packet linking. ED)

-- Earlier in the day, I ran into WB4APR on 10.140 MHz. We tried 300 BPS at 1000Hz shift. Bob used a WESTERN ELECTRIC 202 modem. I had a TAPR TNC with Eric's modifications. Bob copied me with reasonable success, ranging from about 50% beacon reception at the worst to near 90%. I copied two packets successfully. This was less than I was able to achieve with W9TD and WB5IBS two weeks earlier. I have yet to have a good 1000Hz packet QSO.

I asked Bob to switch to 200Hz shift so I could evaluate my demodulator modifications. I was immediately able to copy beacons with a success of 80% or greater.

Next Gary (W9TD) found me. There was no trouble establishing a two-way beacon link. We connected and proceeded with a half hour + QSO. Gary wrote the whole thing to disk while we chatted. I also sent him a short test file.

I should say that Gary ran a BETA board with an external 2206-2211 modem he was testing. I was running pure TAPR TNC with the latest mods. Bob was using either a WESTERN ELECTRIC 202 or a VADIC 103 modem to a VADCG board.

.....
-- More gateway activity. Bob Bruninga (WB4APR) connected two TNCs together back to back. One was pointed toward HF and the other toward the AMRAD packet repeater. I connected with Bob on 10.147MHz LSB, 200Hz shift, 300BPS. Using this gateway I contacted Bill (WB4NFB) of Burke, VA and Rod (WA3MEZ) of Randallstown, MD.

I plan on activating a similar arrangement in the Des Moines area. Then we can have QSOs among stations connected on VHF in their local areas and HF for the long haul link between the gateways.

.....
DAYTON -- DAYTON -- DAYTON

Tucson Amateur Packet Radio will again be represented at the Dayton Hamvention. Look for us at the old booth, but with a new number (303).

There will also be a presentation Friday afternoon in room 2 of the new building. It starts at 3:45, right after Wayne Green, and runs till at least 6:00.

Bob Neben (K9BL) Beta coordinator for Dayton has put in a lot of effort to set up the sessions and will serve as host. Lyle Johnson (WA7GXD) TAPR's president and Pete Eaton (WB9FLW) TAPR vice-president will speak. A special guest will be Paul Rinaldo (W4RI) the Senior Technical Editor of QST.

Drop by and help in the booth, talk with all the packet folks and in general prepare yourself.

-- !! Its DAYTON !! --

I wanted to mention the folks involved in the LA UO-11 command effort.

We have been attempting to command on the 1.2 GHz uplink, unfortunately without success. Phil Karn has been feeding us orbital predictions with frequencies corrected for doppler (there is a lot at 1.2GHz). Phil has new data showing the element set he has been using may have been off far enough that we wouldn't have stood a chance, even with our blast at the sky method. On some of the passes, we picked a spot in the sky through which the s/c should pass and didn't move the array, assuming that even if we were wrong on the time, the s/c ground track should have been close.

We have been using the station of N6CA, Chip Angle. He is running 160 watts into a 340 element array for about 60kw eirp. Wally, WA6JPR and Skip, WB6YMH have provided other equipment and support. Henry Radio Inc., thru Jack, WA6VGS loaned us equipment, including an FM source for 27-30 MHz. LA attempts will resume, after the element set problem is sorted out. We haven't given up hope.

Harold, NK6K.

.....
This is a report on the Central Iowa Technical Society (CITS) investigation of use of the COMMODORE CBM-64 computer for packet radio Computer Bulletin Board System (CBBS) duty. Briefly, our investigation, principally through the efforts of John Maurer, NAGS, and myself, finds the COMMODORE equipment and its operating system to have several deficiencies which preclude a reasonable development project.

The technical details which have resulted in this decision are not very pretty. We discovered, in a very short period of time, serious holes in system software relating to data communications and disk I/O, misleading documentation and very poor and uninterested technical support. We are convinced that most of the system would have to be written in 6502 assembler to properly accomplish what is not reasonably done in COMMODORE BASIC or BIOS65 (when considering the CP/M module).

Consequently, we have redirected our efforts to generic CP/M based software. We will be directly supporting an inexpensive hardware solution based on a popular single-board computer but source code will be available to assist groups interested in running other CP/M compatible hardware. Our first version is currently up and running on a MORROW DESIGN MD-11 system, John has recovered from cardiac arrest after reviewing my preliminary system spec and BIG BOARD type hardware is currently under construction.

I had a short QSO with a member of the Chicago LAN who expressed interest in writing a CBM-64 6502 assembler CBBS system. I will pass the results of our investigation on to him in hopes of developing a replacement CBM-64 project.

73, Ralph Wallio, W0RPK, for the CITS
.....

Dave Altekruze, W6RAW, has been an active packeteer for many years, one of the first in our group, and a RTTYer before that. Dave has access to a UNIX machine which is a node on USENET. For some time now Dave has been feeding USENET mail to our packet mailbox (my Data General) and our packet users like it. Every morning at 2 am an automatic server dumps net.ham-radio and net.micro to our packeteers. Just recently Dave has implemented totally automatic pickup, so that any packeteer can send usenet groups or individuals messages. From USENET messages are relayed to ARPANET, and thence to the rest of the universe.

Each message that was posted has been edited and screened by me, and I hope I have not forwarded any sensitive material. I apologize if anybody was embarrassed.

The recent messages concerned with diagnosing an ailing satellite I don't consider to be "airing dirty linen", but an extremely interesting and fascinating behind-the-scenes story of the operational activities of the AMSAT membership. This kind of stuff is not found in most ham journals, and is stale when published six months later.

So my motives are to keep a wider ham community informed of what's going on, and to pass along information which will generate more interest and will hopefully result in more packeteers and more AMSAT members. Meanwhile, all this traffic keeps our local metronet humming.

In answer to Harold's question of what have I been doing lately, most of my free packet time (when I'm not planning or running a PPRS meeting or talking to a local ham group) has been spent building, testing and running packets through AO10. I have started a weekend bulletin service on the AMICON channel, and have broadcasted to the world all of the 1984 bulletins which have accumulated in our packet mailbox. These bulletins may be heard around apogee on weekends, whenever the satellite is in view of CA and the time is reasonable (not the middle of the night.)

73s Hank Magnuski, KA6M
.....

HAL SYSTEM OWNERS:

I am interested in exchanging technical information relative to integration of the TAPR TNC with the Hal DS-3100 ASR as a stand alone terminal or integrated with the MPT-3100, DSK-3100, ST-6000, and ARQ-1000 configured in different variants for a multipurpose RTTY, AMTOR, and Packet Radio HF/VHF Bulletin Board System.

Contact : Bill Talanian
W1UJQ
860 Serenidad Place
Goleta, CA 93117

Home : (805) 964-7432
Business: (805) 967-5511 (Extension 2443)
.....

(BBS WATCH continued from page 6)

Here is where the BBS WATCH can help, let us know of your activities and needs. If you would like a group buy of SBC cards let it be known. Perhaps the group can determine a configuration and find all the components that are needed. Or if you find a good deal on some parts, for instance disk drives or power supplies, pass it along so others may benefit.

There are other issues that need to be talked about. Items like "virtual screens" so material sent from a BBS can appear on any CRT, be it 20 or 135 columns wide. Also cursor control commands for different terminals attached to the TNC are not the same. The ability to randomly address a location on a page will add a great deal to our effectiveness. Later we can talk of graphics and other extras. That is for another issue.

Packet Frequency Coordination

We are operating on many different VHF/UHF frequencies across the country. If each site would send this information to PSR, we could print a directory. Regional and national coordination is a topic that needs to be resolved soon!

TNC Availability

by Chuck Green, N0ADI

There are actually a few kits sitting here with no one to send them to! They will probably be gone by the time you read this; telling you is only to dramatize that we have almost eliminated the backlog. Recently, kits were shipped just as soon as the check for final payment cleared.

Additionally, a large supply of parts are due soon. While there is no guarantee that these parts will arrive on time (we usually have to yell at at least one supplier) and there is no way to be sure of the volume of future orders, we believe we will soon be in a position to ship from stock.

.....
The Tucson Amateur Packet Radio Corporation is a nonprofit scientific research and development corporation. The Corporation is licensed in the State of Arizona for the purpose of designing and developing new systems for packet radio communication in the Amateur Radio Service, and for freely disseminating information acquired during and obtained from such research.

The officers of the Tucson Amateur Packet Radio Corporation are:

Lyle Johnson WA7GXD ... President
Pete Eaton WB9FLW ... Executive VP
Heather Johnson .. N7DZU Secretary
Chuck Green N0ADI Treasurer

The Packet Status Register is the official publication of the Tucson Amateur Packet Radio Corporation. Explicit permission is granted to reproduce any material appearing herein, providing credit is given to the author and TAPR.

Yes, the months of waiting for a TAPR TNC are over. **YOU CAN PROBABLY GET A TNC KIT QUICKLY!** If you have made a deposit but not the final payment, do so right away. If you have just decided to order a TNC Kit, we would suggest sending in the full payment. Sending just a deposit will probably result in an immediate request for the final payment; this process will likely just result in delaying shipment of your kit.

Tell your friends:

TNC KITS ARE NOW AVAILABLE WITHOUT A LONG DELAY!

.....
PSR Mailing address: (PSR editorial material only)
Minnesota Amateur Packet Radio
c/o Pat Snyder, WA0TTW
University of MN Computer Center
208 Union Street S.E.
227 Experimental Engr. Bldg.
Minneapolis, MN 55455

via CompuServe Information Service:
70225,1252

TAPR HF Nets:
21.280 MHz 7.158 MHz
1900Z Sundays 2100Z Sundays

The Packet Status Register is edited and prepared by the following members of the MAPR group in the Twin Cities using material contributed from wherever we can get it:

Pat Snyder WA0TTW
Paul Barnett N0CRJ

Tucson Amateur Packet Radio Corporation
P.O. Box 22888
Tucson, AZ. 85734



Check YOUR address label for
membership EXPIRATION date !