



High Performance Software Defined Radio

OpenHPSDR Project Update
May 2010

Scotty Cowling, WA2DFI

2010 Dayton Hamvention





What is OpenHPSDR anyway?

*H*igh *P*erformance *S*oftware *D*efined *R*adio

An SDR in general is a radio that has

- ❑ Primary functionality (mod/demodulation, filtering, etc) defined in software
- ❑ DSP algorithms implemented in configurable hardware and/or PC software

Best known examples of SDRs

- ❑ FlexRadio Systems SDR-1000/FLEX-5000
- ❑ Tony Parks, KB9YIG's Softrock series of kits

An OpenHPSDR specifically is a radio with the following features:

- ❑ Very High Performance
- ❑ Based upon an open source model (OHL/NCL hardware, GPL software)
- ❑ Modular and expandable
- ❑ Contributes to the advancement the State of the Radio Art



What is the OpenHPSDR Project...?

The OpenHPSDR Project is a modular, open source hardware and software platform for development of all components of a Software Defined Radio.

It is also a group of volunteers dedicated to the building of a pool of open-source Software Defined Radio design information.



TAPR's MISSION



Support OpenHPSDR development with:

R&D funding

- Breadboard prototypes
- Alpha PCBs

Early volume production

- Put leading edge technology into many hands

Result: Ever growing pool of contributors, experimenters and subsequent advancement of the radio art

OpenHPSDR and TAPR are separate entities

They complement each other



How about AMSAT?



AMSAT supports OpenHPSPDR with software tools

- ❑ Schematic capture software
- ❑ Simulation software
- ❑ PCB layout software

AMSAT supports OpenHPSPDR with hardware tools

- ❑ SMT rework equipment

AMSAT supports OpenHPSPDR overcome financial hurdles

- ❑ Janus/Ozy production loan



The Boards

Basic OpenHPSDR Board Set

- ❑ **ATLAS:** The Backplane
- ❑ **Pinocchio:** The Extender
- ❑ **Magister:** USB gateway
- ❑ **Janus:** Baseband A/D and D/A Converter
- ❑ **Penelope:** Transmitter/Exciter
- ❑ **Mercury:** Direct Sampling Receiver
- ❑ **LPU:** Linear Power Unit



The Boards

Useful Additions

- ❑ **Pandora:** Enclosure
- ❑ **Pennywhistle:** 20W PA
- ❑ **Excalibur:** 10MHz reference
- ❑ **Hercules:** 100W PA
- ❑ **DJ8AY:** Atlas 3-slot backplane
- ❑ **DJ8AY:** Antenna Switch and 6M LNA



The Boards

Coming Soon (or not so soon)

- ❑ **Alexiades:** RF Bandpass Filters
- ❑ **Hermes:** DUC/DDC transceiver
- ❑ **Apollo:** 15W PA/LPF/ATU
- ❑ **Aussie II:** Gigabit Ethernet Gateway
- ❑ **Phoenix:** QSD/QSE Receiver/Transmitter
- ❑ **Cyclops:** 1GHz Spectrum Analyzer



Atlas Backplane

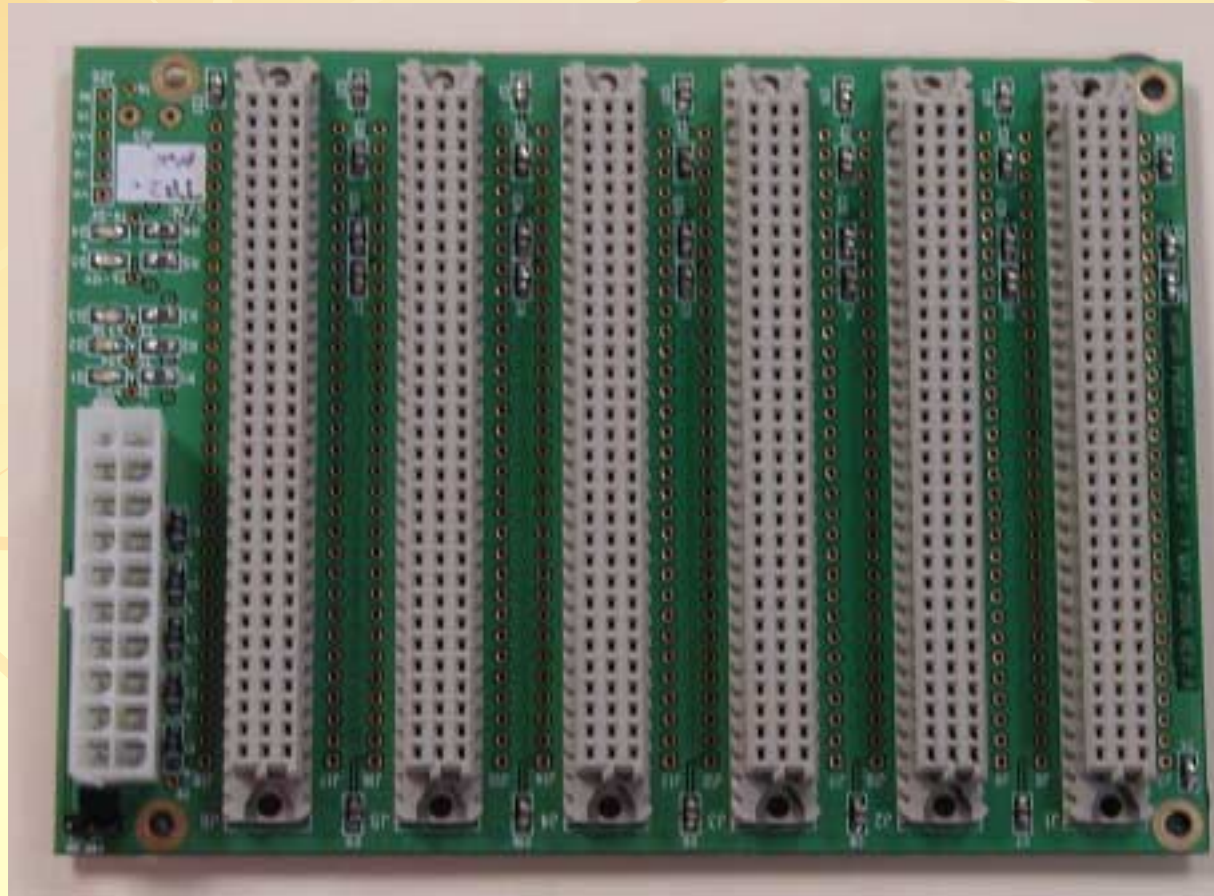



Atlas Backplane

- ❑ Six slot backplane
- ❑ 4-layer PCB
- ❑ Non terminated bus
- ❑ ATX power connector
- ❑ LED power indicators
- ❑ Power with LPU/bench supply or ATX power supply

Status:

Kits available from TAPR



Pinocchio Extender





Pinocchio Extender

- Extends test board above others in Atlas backplane
- Test points for Atlas bus signals

Status:

Kits available from TAPR



Ozymandias USB Gateway

USB interface to Atlas bus with parallel I/O





Ozymandias USB Gateway

Ozy Quick Specs

- ❑ Cypress FX2 microcontroller USB 2.0 interface to PC
- ❑ Altera EP2C8 Cyclone II FPGA interface to Atlas bus
- ❑ User I/O interfaces directly to SDR-1000
- ❑ Standard 120mm x 100mm Atlas plug-in board

Status:
Unavailable



Magister USB Gateway

USB interface to Atlas bus

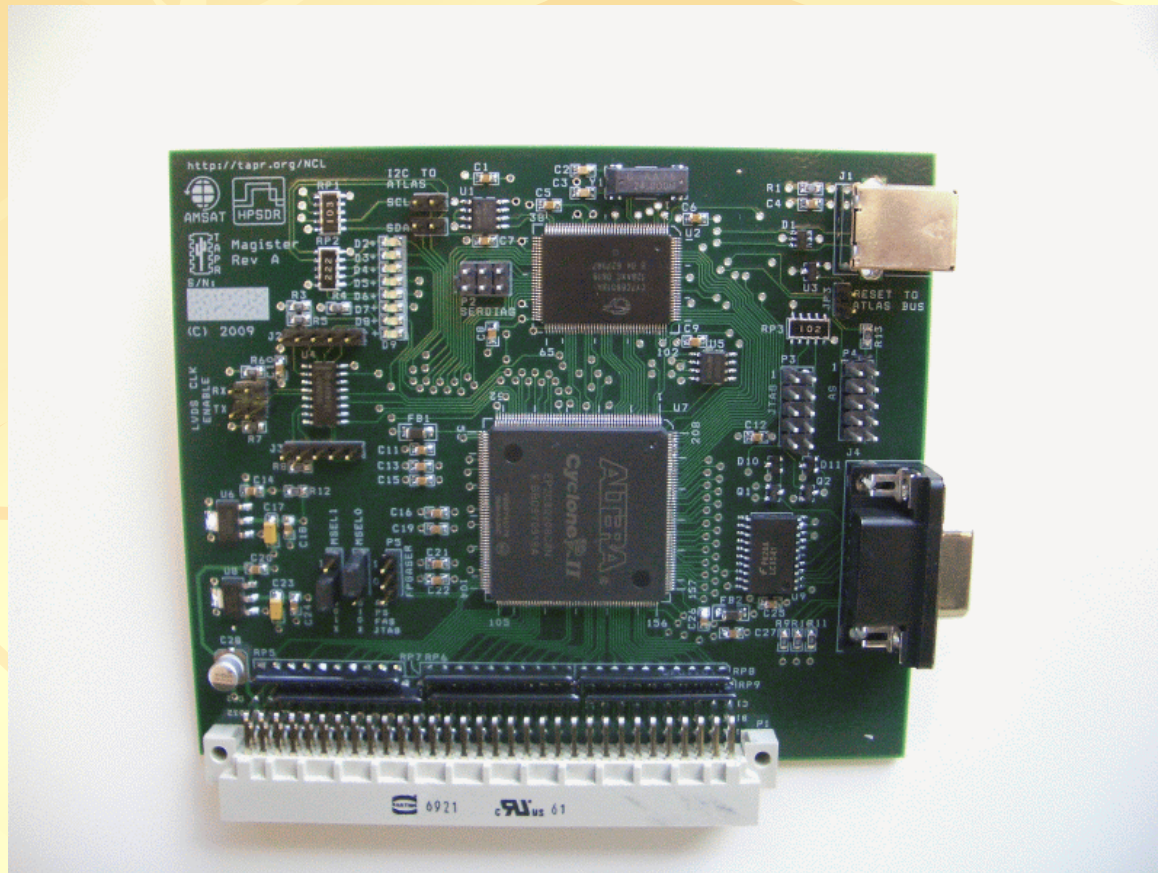



Magister USB Gateway

Magister Quick Specs

- ❑ Cypress FX2 microcontroller USB 2.0 interface to PC
- ❑ Altera EP2C8 Cyclone II FPGA interface to Atlas bus
- ❑ ESD protection on USB 2.0 port
- ❑ Parallel I/O for PTT/paddle
- ❑ Standard 120mm x 100mm Atlas plug-in board



Magister USB Gateway

Magister Compared to Ozy

- ❑ Same FX2 USB 2.0 interface to PC – no SW changes
- ❑ Same EP2C8 FPGA interface – no firmware changes
- ❑ Added ESD protection on USB 2.0 port
- ❑ Limited user I/O for PTT/paddle
 - ❑ 2 OC outputs, 2 TP outputs, 3 inputs
- ❑ No SDR-1000 support – DB25 and option resistors removed
- ❑ Removed: RS-232 level shifters, 1-wire driver, FPGA GPIO
- ❑ Removed: four LEDs (Magister has 8, Ozy has 12)
- ❑ Entirely new PCB layout released under TAPR NCL



Magister USB Gateway

Status:

Assembled boards available from TAPR



Janus A/D – D/A Converter

High speed full-duplex A-to-D and D-to-A converter

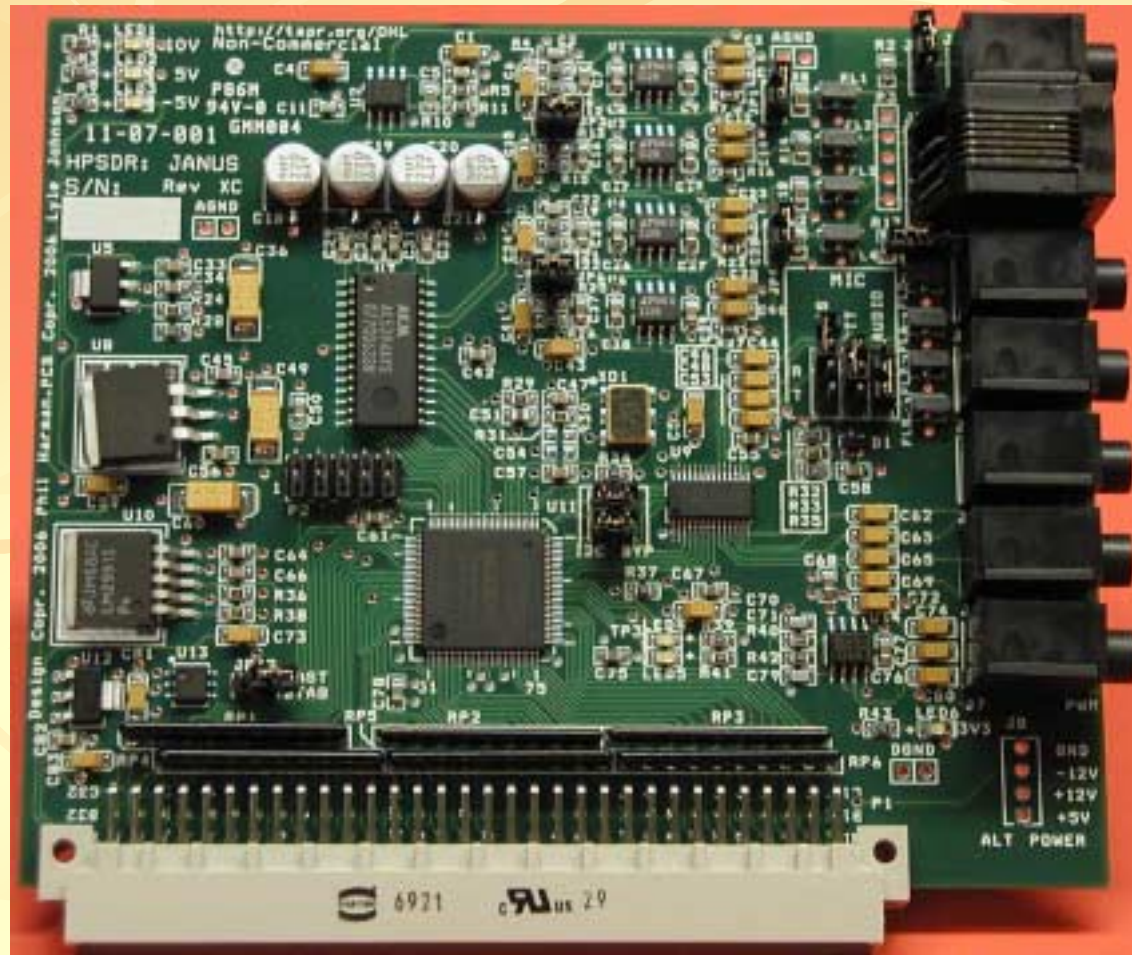



Janus A/D – D/A Converter

Janus Quick Specs

- ❑ Altera EPM240 CPLD interface to Atlas bus
- ❑ AK-5394A stereo 24-bit 192ksps ADC for I/Q input
- ❑ TLV-320A 48ksps CODEC for mic, line, phones
- ❑ PWM audio outputs
- ❑ Standard 120mm x 100mm Atlas plug-in board

Status:

Assembled and bare boards available from TAPR



Penelope Transmitter/Exciter

Digital Up Conversion (DUC) ½ W transmitter/exciter





Penelope Transmitter/Exciter

Penelope Quick Specs

- ❑ 1.8 - 55MHz frequency coverage with 0.5W pep output
- ❑ Low level transverter output
- ❑ RF phase and magnitude outputs for future Envelope Elimination and Restoration (EER) power amplifier
- ❑ Open drain FET for PTT control of external amplifiers
- ❑ Seven open collector outputs for linear, relay control, etc.
- ❑ Optional on board microphone ADC for use without a Janus card
- ❑ 122.88 MHz crystal oscillator locked to 10MHz TCXO
- ❑ Altera EP2C8 Cyclone II FPGA based DUC for easy code upgrades
- ❑ Atlas bus compatible, USB interface to PC via Ozy board
- ❑ Standard 120mm x 100mm Atlas plug-in board



Penelope Transmitter/Exciter

Status:

Bare and assembled boards available from
Gerd, DJ8AY



Mercury Direct Sampling Receiver

0-65MHz direct sampling receiver





Mercury Direct Sampling Receiver

Mercury Quick Specs

- ADC overload
 - -12dBm (preamp on)
 - +8dBm (preamp off)
- MDS (500Hz)
 - -138dBm (160m - 6m, preamp on)
 - -118dBm (160m - 6m, preamp off)
 - -146dBm (6m via Alex preamp)
- IP3 equivalent (independent of spacing)
 - +33dBm (preamp on)
 - > +50dBm (preamp off)
- Blocking Dynamic Range (1dB GC)
 - 119dB @ 100kHz
 - 119dB @ 5kHz
- 122.88MHz clock phase noise
 - -149dBc/Hz @ 1kHz

The BDR is set by the overload point of the ADC and is *NOT* phase noise limited



Mercury Direct Sampling Receiver

Status:

Assembled and bare boards available from TAPR



LPU

Linear Power Unit





LPU

LPU Quick Specs

- ❑ Regulated DC Input
 - ❑ 12.5VDC – 14.5VDC (nominal 13.8VDC)
- ❑ Regulated DC Outputs
 - ❑ +13.8V @ 10A unfused pass-through
 - ❑ +12.0V @ 2.0A
 - ❑ +5.0V @ 1.5A
 - ❑ -12.0V @ 100mA (can be disabled to reduce noise)
 - ❑ +3.3V @ 1.0A (optional)
- ❑ Plugs directly onto Atlas backplane, fits within Pandora chassis
- ❑ Requires forced air cooling at higher currents (has fan connector)



LPU

Status:

Kits available from TAPR



Pandora Enclosure

OpenHPSDR Chassis



© 2010 Scotty Cowling WA2DFI



Pandora Enclosure

Pandora Quick Specs

- ❑ Enclosure for:
 - ❑ Atlas backplane with six plug-in boards
 - ❑ LPU
 - ❑ 92mm cooling fan
 - ❑ Alex bandpass filter board set in sub-enclosure
 - ❑ Space for power amplifier (such as Pennywhistle)
- ❑ Removable lid for plug-in board access
- ❑ Individual block-off plates for each Atlas slot
- ❑ Pre-drilled and silk-screened for Atlas, LPU and Alex
- ❑ Dimensions 12.2"W x 8.7"D x 5.3"H (31cm x 22cm x 13.5cm)



Pandora Enclosure

Status:
Available from TAPR



Pennywhistle 20W PA

20W Power Amplifier

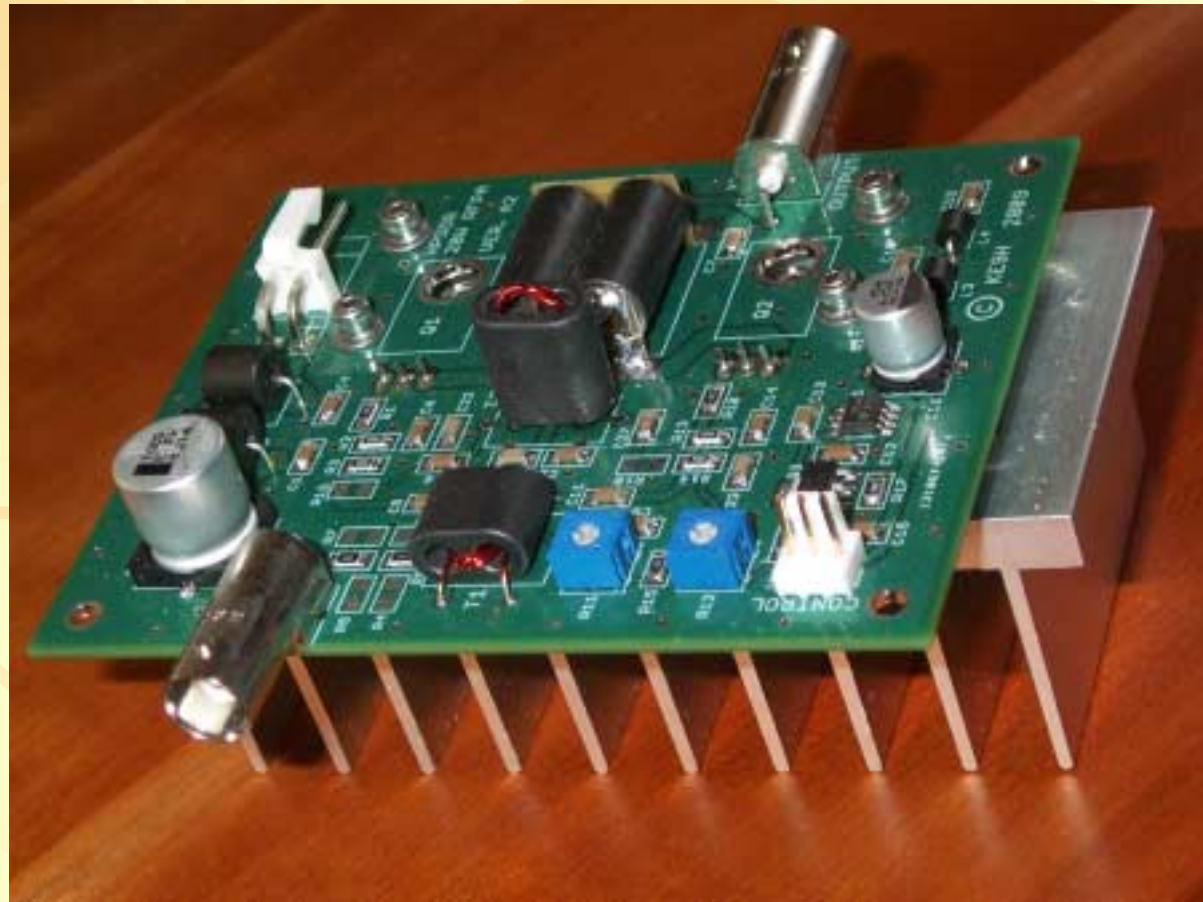



Pennywhistle 20W PA

Pennywhistle Quick Specs

- ❑ Power requirement: 13.6VDC
- ❑ Nominal drive requirement: 250mW
- ❑ Power Output: 16W PEP, 20W CW
- ❑ Frequency of Operation: 160M through 6M
- ❑ Nominal Gain: 19dB
- ❑ Size: 100mm X 80mm (half Euro-board)
- ❑ Push-pull output
- ❑ Requires LPF (such as Alex) for use with Penelope



Pennywhistle 20W PA

Pennywhistle 20W Power Amplifier

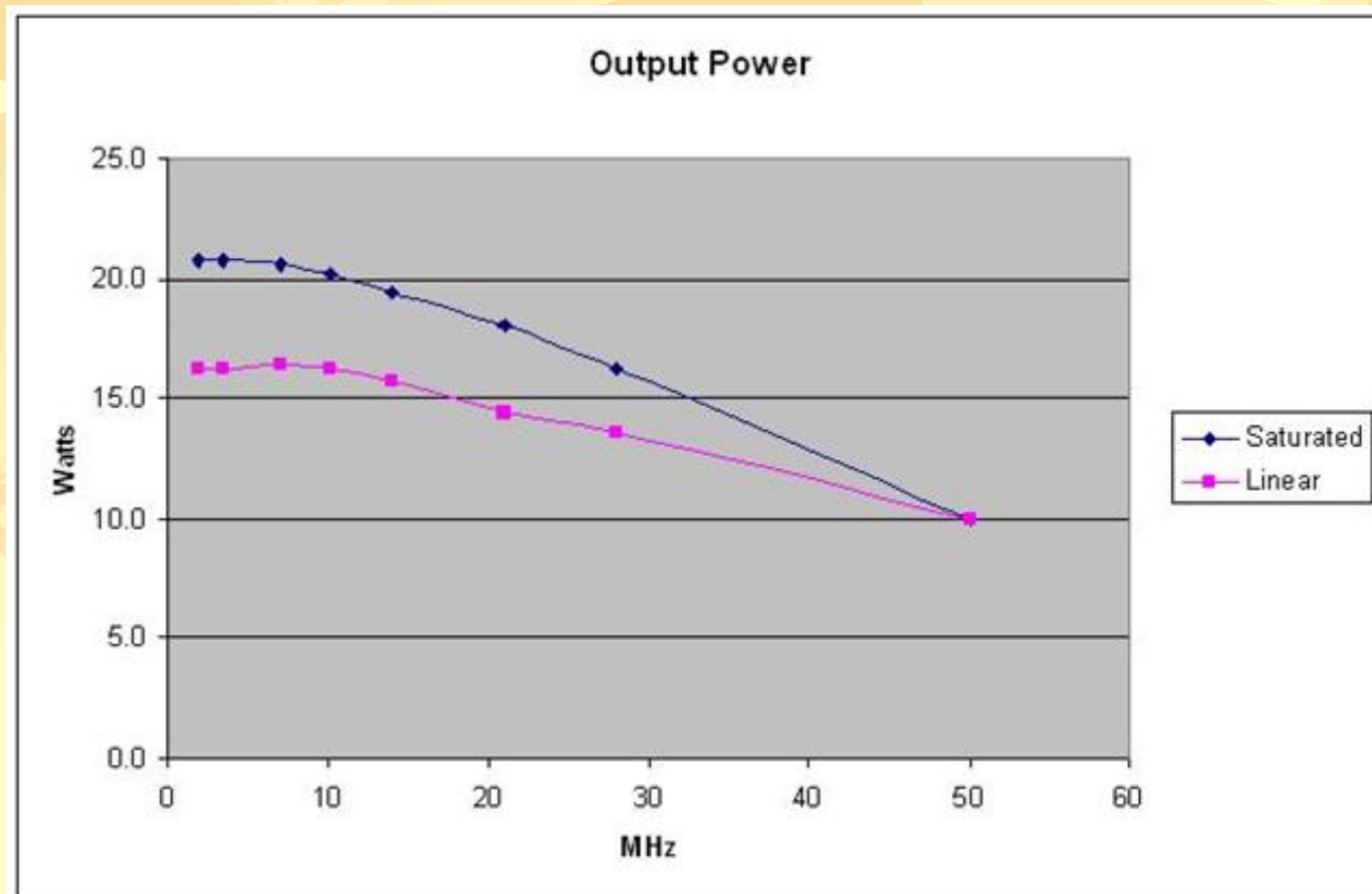



Pennywhistle 20W PA

Status:

Kits available from TAPR



Excalibur 10MHz Reference

10MHz Clock Reference

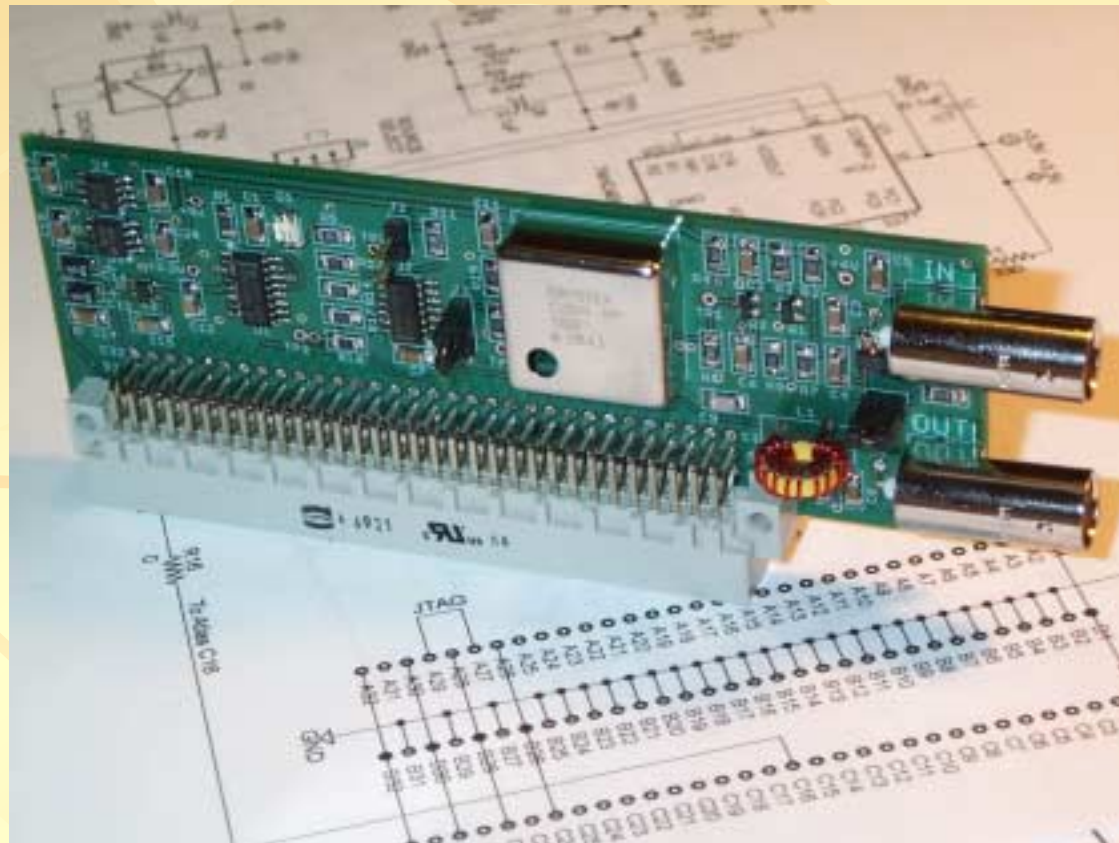



Excalibur 10MHz Reference

Excalibur Quick Specs

- ❑ Source select:
 - ❑ Sine/square wave @ 10MHz from GPS-DO (typ +/- 0.0001ppm)
 - ❑ On-board high-stability (+/- 1ppm) TCXO
- ❑ Simultaneous 10MHz Outputs:
 - ❑ Square wave to Atlas bus clock pin C16 (jumperable)
 - ❑ Square wave to Mercury aux-clk (2-pin header)
 - ❑ +8.5dBm sine wave to external equipment (BNC)
- ❑ LED frequency/phase detector for TCXO alignment
- ❑ Short Atlas card, 120mm X 40mm



Excalibur 10MHz Reference

Excalibur 10MHz Clock Reference

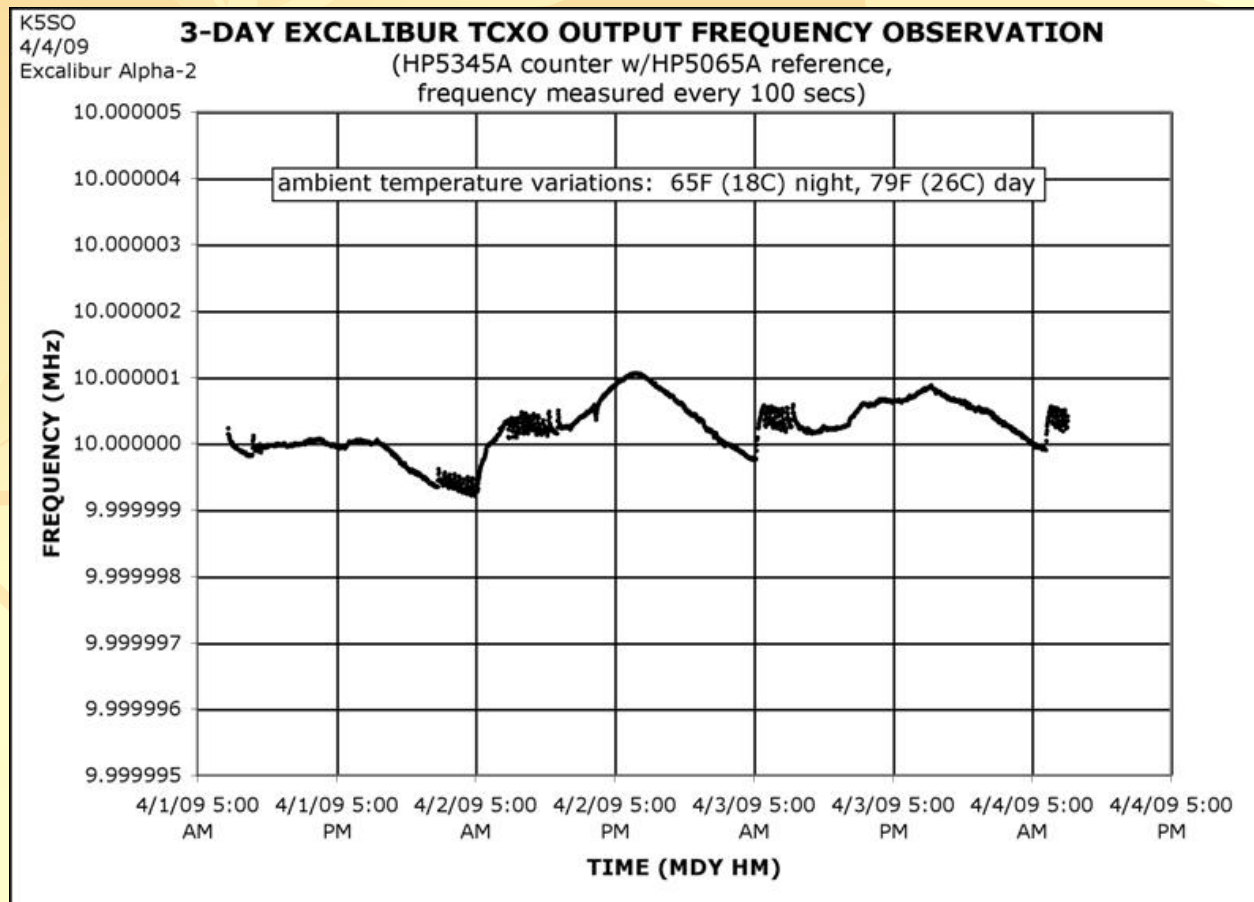



Excalibur 10MHz Reference

Status:

Kits available from TAPR



DJ8AY OpenHPSDR boards

OpenHPSDR Boards available from DJ8AY

- ❑ Penelope ½W DUC Transmitter
- ❑ Hercules 100W PA
- ❑ 3-slot Atlas backplane
- ❑ Antenna T/R switch and 6M LNA

Orders taken via email or check eBay:

Gerd Loch DJ8AY

g.loch@nt-electronics.de



DJ8AY OpenHPSPDR boards

Antenna T/R Switch and 6M LNA

- ❑ 6M LNA (optional module)
 - ❑ 25dB gain
 - ❑ 1.7 dB noise figure
- ❑ RX protection relay and diode
- ❑ T/R switching from Penelope PTT_OUT
- ❑ Available now





DJ8AY OpenHPSDR boards

6M stand-alone LNA

- ❑ 6M LNA
 - ❑ 25dB gain
 - ❑ 1.7 dB noise figure
- ❑ Can be integrated onto T/R switch board or used standalone
- ❑ Available now





DJ8AY OpenHPSDR boards

Hercules 100W PA

- ❑ Covers 160M – 6M
- ❑ 7 LPFs on-board (can also be used on RX)
- ❑ uC Temp, Current, VSWR monitor drives external LCD
- ❑ Penelope interface
- ❑ 185x130mm
- ❑ Kits available now





Alexiares RF Bandpass Filters

RF Preselector/TX LPF/6M Preamp/T-R Switch

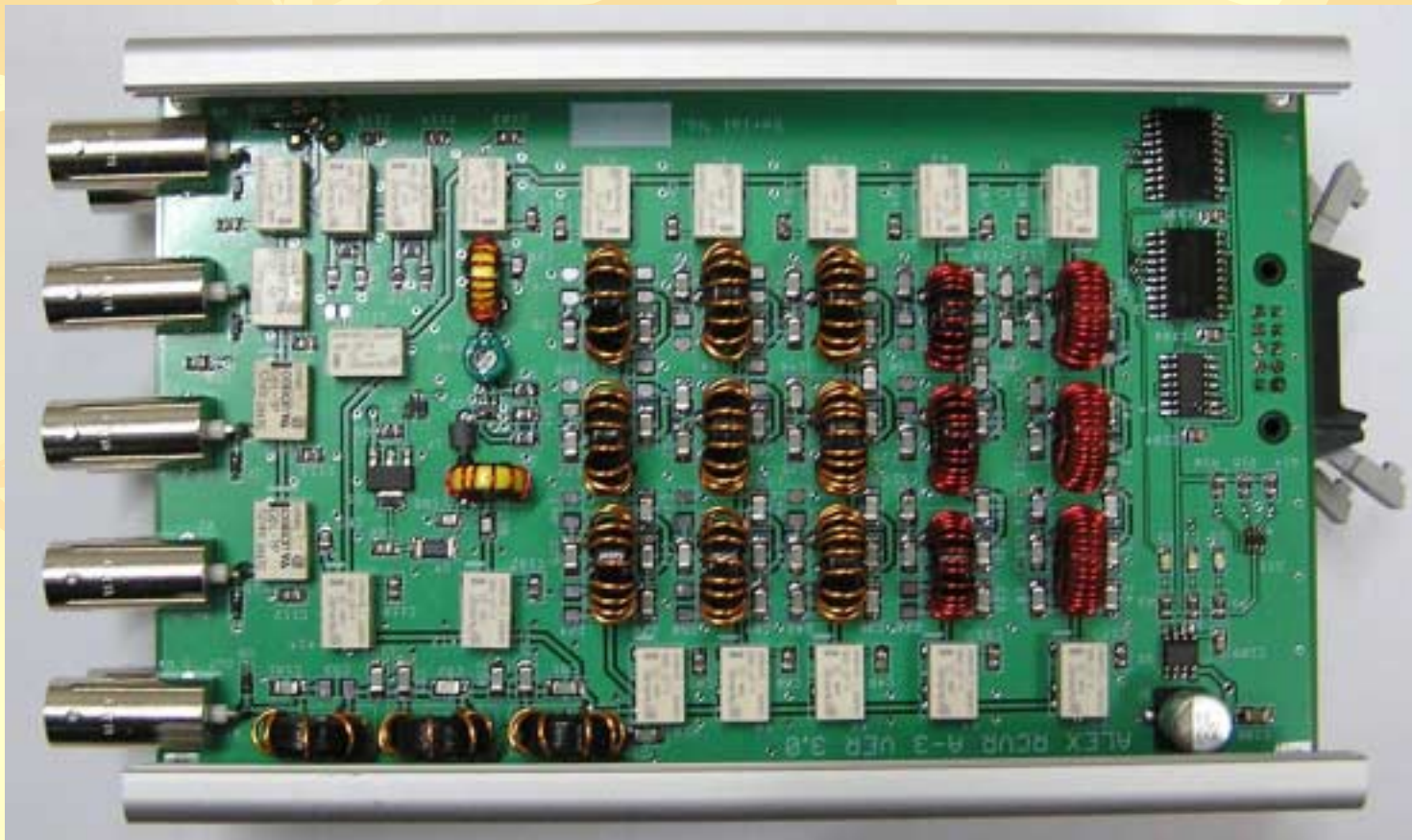



Alexiares RF Bandpass Filters

Alex Quick Features

- ❑ Two board set
 - ❑ RX-HPF High-Pass Filter board
 - ❑ TX-LPF Low-Pass filter board
- ❑ 160mm x 100mm boards fit into standard Euroboard housing
- ❑ SPI bus controlled (from Mercury or other SPI)
- ❑ Power requirement: nominal +12V @ 180mA maximum
- ❑ Can operate stand-alone for other applications
- ❑ Low insertion loss
 - ❑ < 2.0dB on receive paths, < 0.5dB on transmit paths
- ❑ No degradation of Mercury IP3
- ❑ No continuously running internal oscillators



Alexiares RF Bandpass Filters

Alex TX-LPF Features

- ❑ Four External BNCs
 - ❑ Three antenna connections
 - ❑ RF from transmitter
- ❑ Internal SMB for antenna connection to RX-HPF board
- ❑ Forward and reverse log amps for RF power measurement
- ❑ Unswitched 6m low-pass filter
- ❑ One of seven relay switchable series elements
 - ❑ One of six LPFs: 160m - 80m - 60/40m - 30/20m - 17/15m - 12/10m
 - ❑ Bypass
- ❑ T/R antenna switching
- ❑ Rated at 100W peak power



Alexiares RF Bandpass Filters

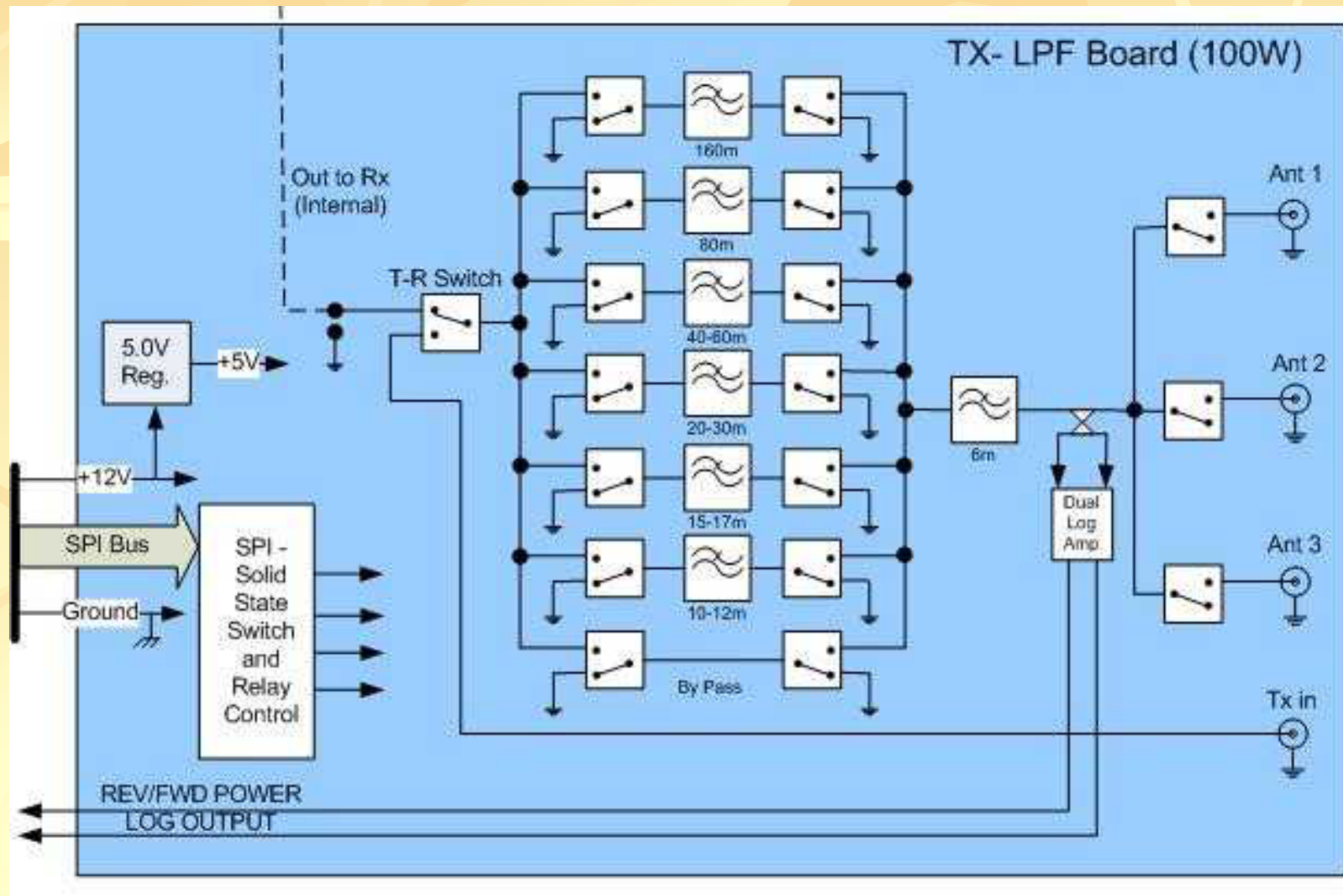



Alexiares RF Bandpass Filters

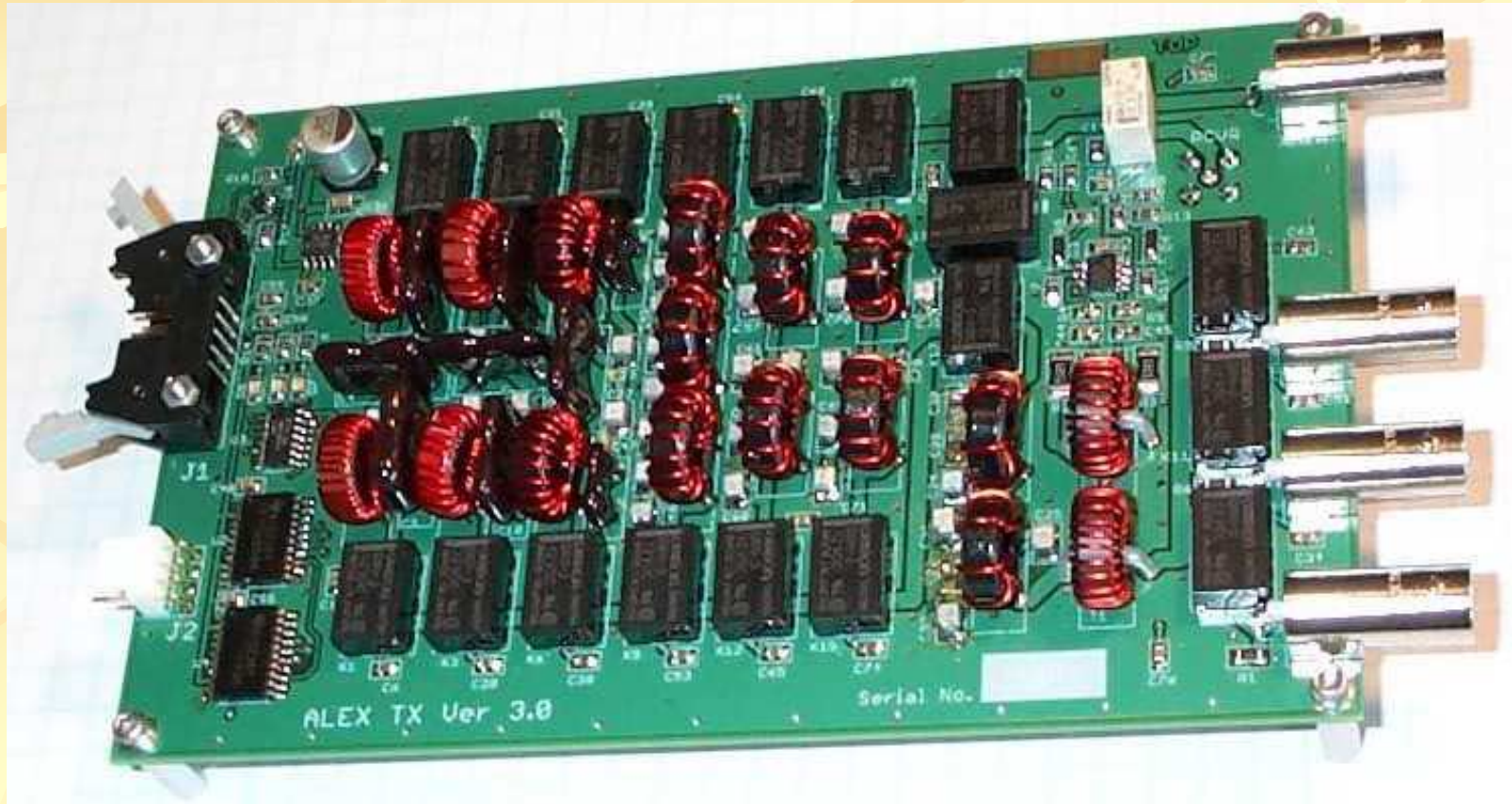

Alex TX-LPF Board

© 2010 Scotty Cowling WA2DFI



Alexiares RF Bandpass Filters

Alex RX-HPF Features

- ❑ Internal SMB for antenna connection from TX-LPF board
- ❑ Five External BNCs
 - ❑ From transverter receiver
 - ❑ Two auxiliary receive-only antenna inputs
 - ❑ From internal SMB TX-LPF connector
 - ❑ Filtered output to main receiver
- ❑ One of four relay switchable attenuation levels
 - ❑ 0dB - 10dB - 20dB - 30dB
- ❑ One of seven relay switchable series elements
 - ❑ One of five HPFs: 1.5 - 6.5 - 9.5 - 13 - 20 MHz
 - ❑ 6m LNA
 - ❑ Bypass
- ❑ Unswitched 55Mhz anti-aliasing LPF



Alexiares RF Bandpass Filters

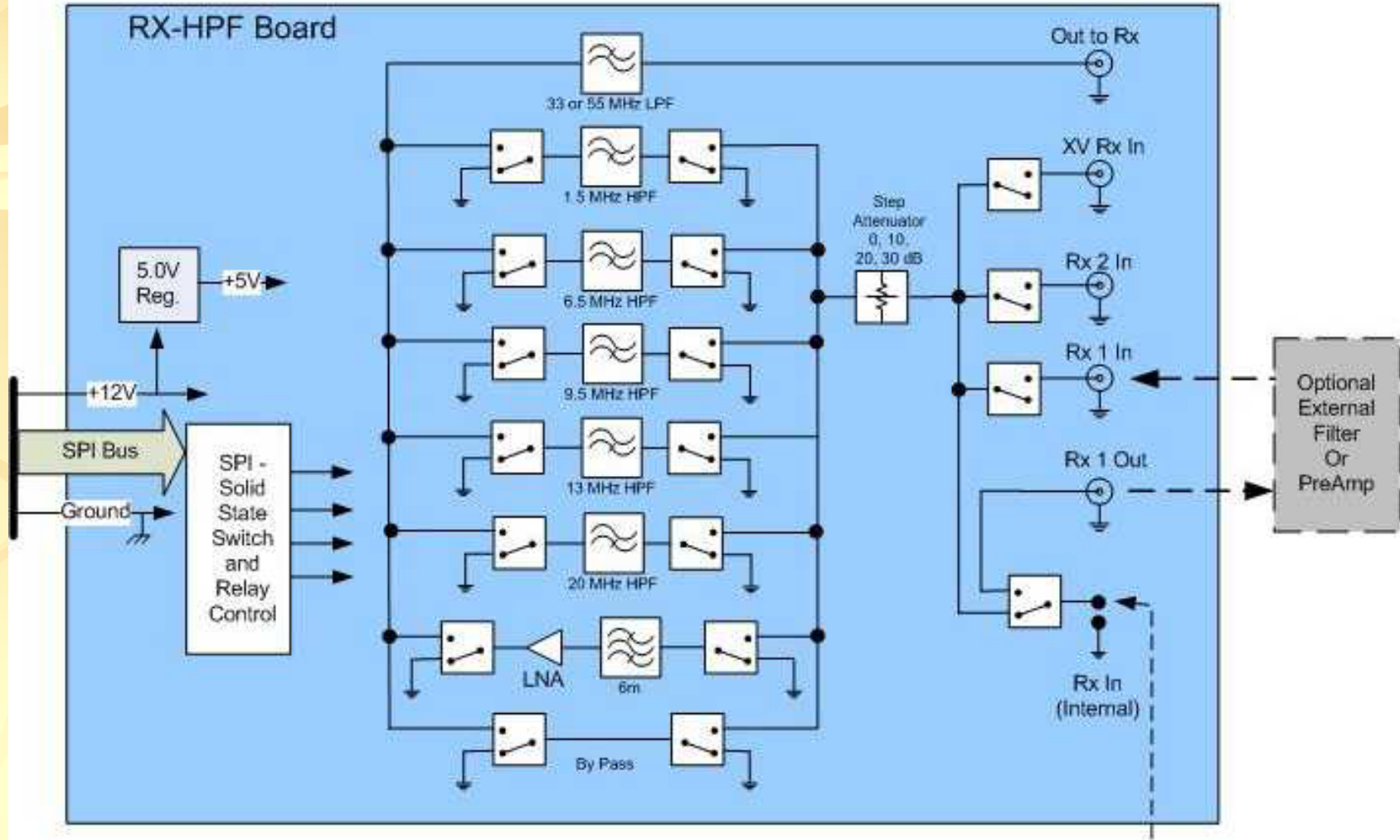



Alexiares RF Bandpass Filters

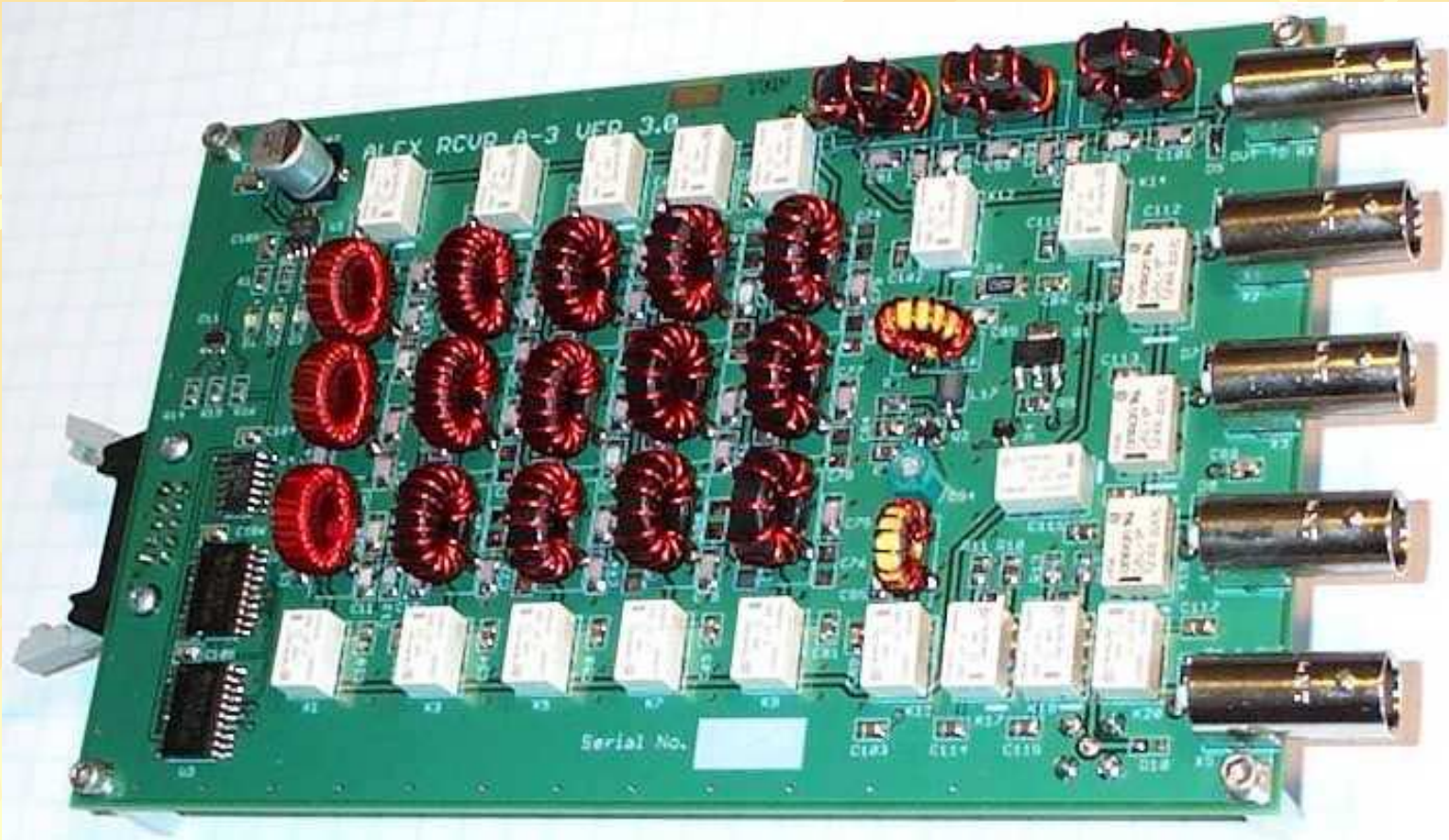

Alex RX-HPF Board



Alexiares RF Bandpass Filters

Toroid Hell Explained

- ❑ Alex designed/tested with Micro-Metals and Fair-Rite cores
- ❑ Production costs dictated off-shore coil winding
- ❑ Permeability of Yangtze mud is different from standard cores
- ❑ Tested to determine suitability to task of new core material
- ❑ Re-designed and re-tested Alex using samples of new core material
- ❑ Shipped some raw cores for winding off-shore
- ❑ Now need to confirm that production cores are correct before build



1000 assembled PCB with wrong toroids = BAD!



Alexiares RF Bandpass Filters

Can you spot the difference between these two cores?



?

=



You may have a bright future in Toroid Winding!

(please see me after class)



Alexiares RF Bandpass Filters

- ❑ Alpha 1 boards funded by developers, August 2007
- ❑ Alpha 2 boards funded by TAPR, January 2008
- ❑ Alpha 3 board funded by TAPR, March 2008
- ❑ Qualification of new core material, Nov 2009 – Feb 2010
- ❑ **Toroids shipped from China on 6 May 2010!!!!**
- ❑ Off-the-shelf enclosure; custom panels will be available

Status:

TAPR production run scheduled for July 2010
Fully Assembled and Tested and bare PCBs



Remember Alice?

This isn't what I want to talk about...





Hermes

Single-board DUC/DDC Transceiver

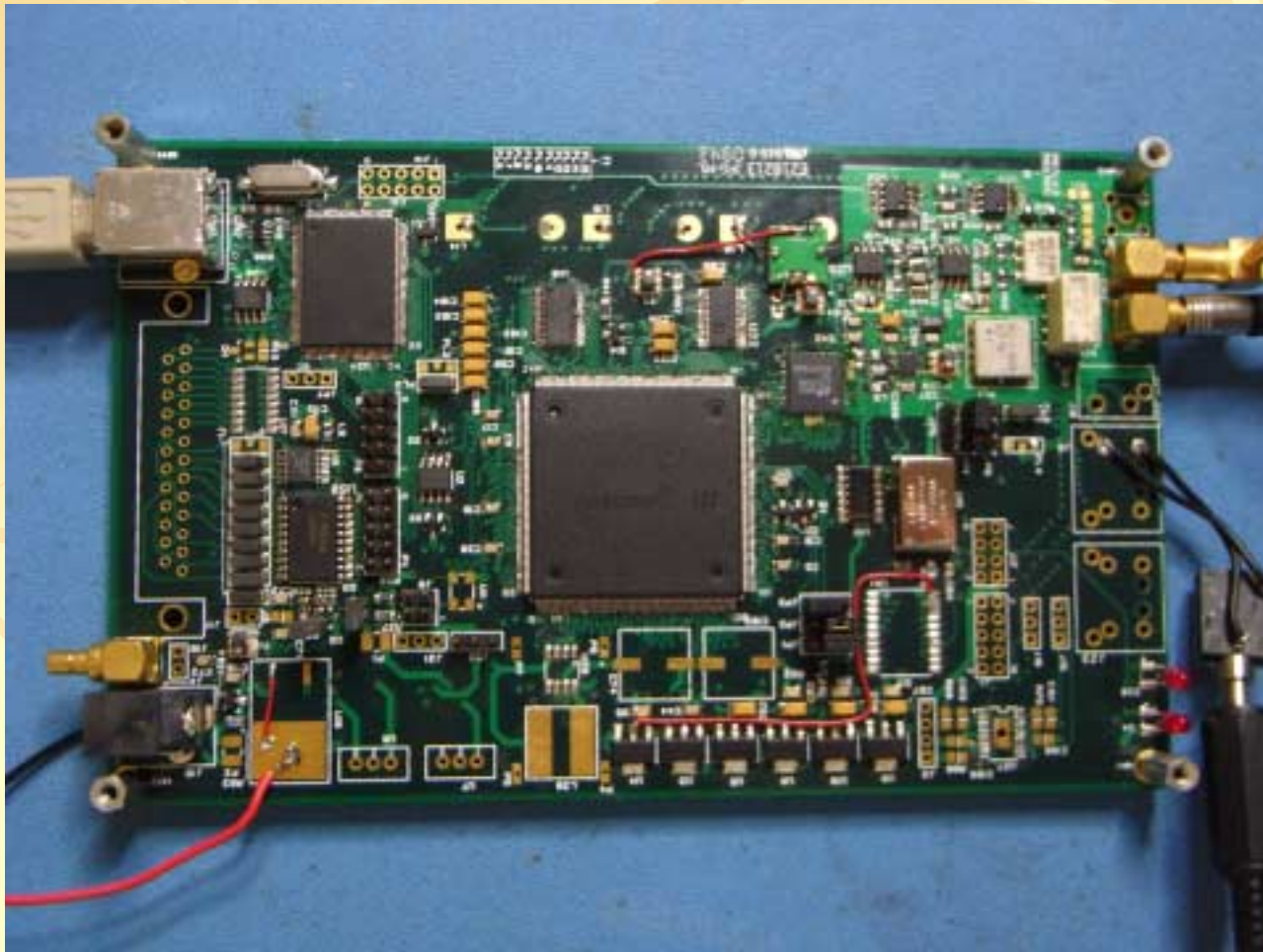



Hermes

Magister

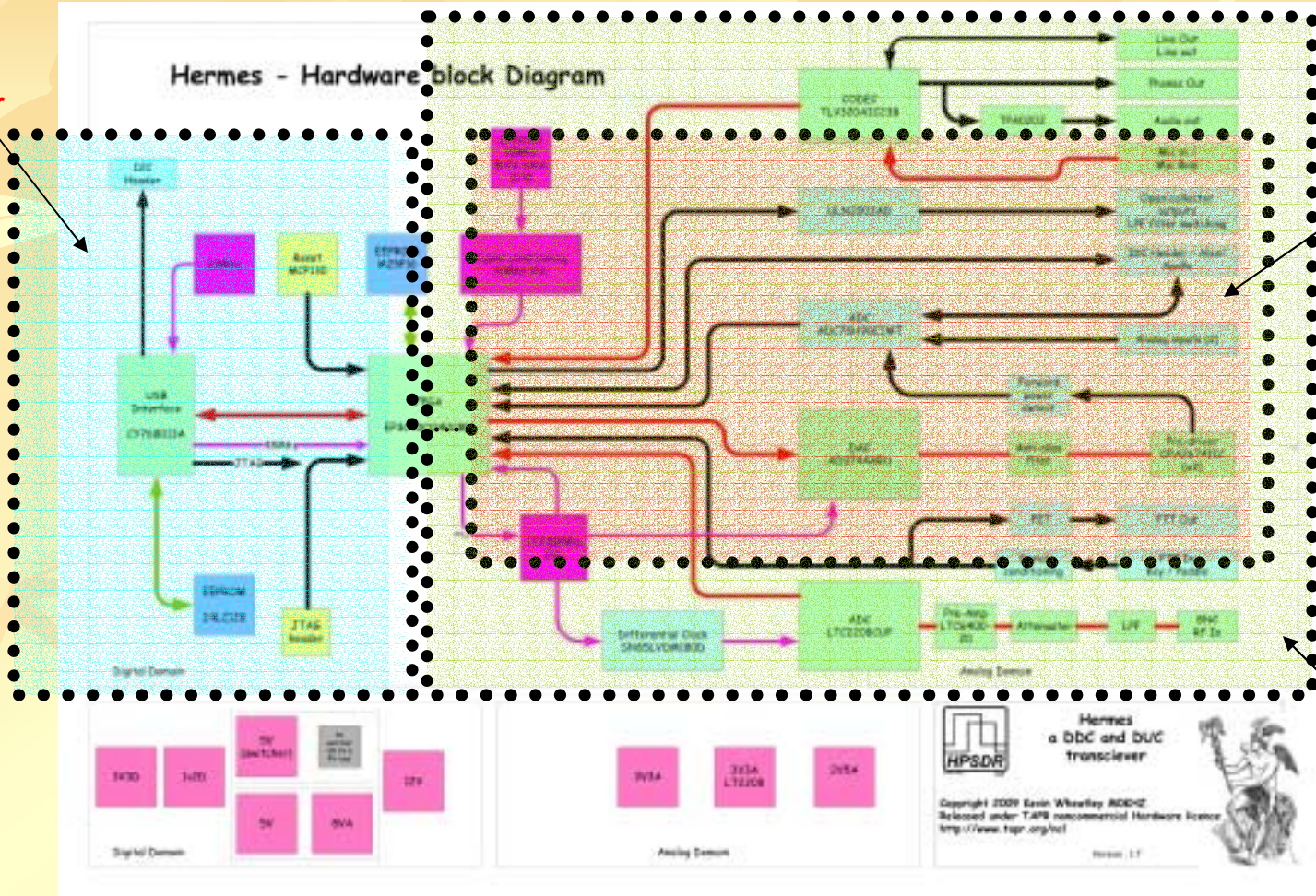

Penelope

Mercury

Hermes DUC/DDC Transceiver

© 2010 Scotty Cowling WA2DFI



Hermes

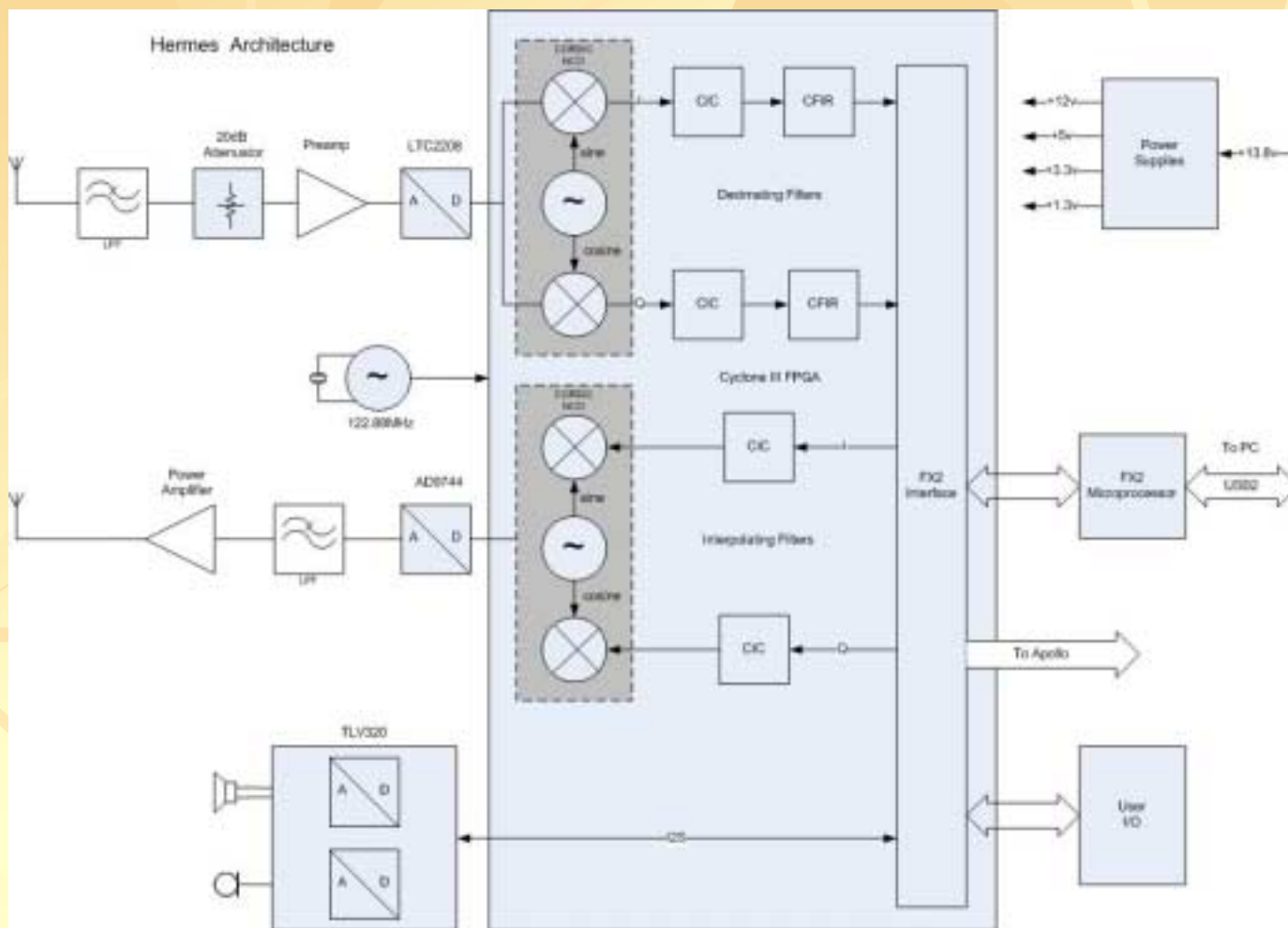

Hermes DUC/DDC Transceiver Architecture

© 2010 Scotty Cowling WA2DFI



Hermes

Single-board DUC/DDC Transceiver Features

- Direct Sampling RX and Direct Up Conversion TX on single board
 - Mercury front end/sampling section: continuous 50kHz – 54MHz coverage
 - Penelope CODEC and TX section with modified 500mW PA
- Single Altera EP3C40 Cyclone III FPGA for filtering and data processing
- Diode protected USB 2.0 interface to PC
- SPI Interface to Apollo
- Digital I/O: 7 - OC digital outputs, 3 - digital inputs, 4 - 12 bit analog inputs
- Key, paddle and PTT inputs, jumper selectable electret microphone bias
- Input attenuator: 20dB software switchable
- Preamp: -135dBm noise floor (@500Hz BW)
- On-board low noise SMPS: typical 400mA from 13.8V supply
- Standard 100mm x 160mm EuroCard



Hermes

Single-board DUC/DDC Transceiver Features, cont'd

- ❑ Full-duplex operation, *any frequency/mode split*
- ❑ 122.88MHz master clock, can be locked to TCXO or external reference (GPS)
- ❑ Stereo audio: 1W speaker out, headphone out, line out
- ❑ Dedicated 0dBm transverter output
- ❑ TX/RX image rejection: greater than 110dB
- ❑ Blocking Dynamic Range (BDR): typical 125dB
- ❑ Eight independent receivers will fit can be implemented within FPGA
- ❑ Software support: KISS Konsole, PowerSDR, GHPSDR

Status:

Three prototypes built and tested on two different artworks
Final testing complete, production PCB nearly ready to order



Hermes PA Testing

500mW Hermes PA

- ❑ Penelope PA (OPA2674) runs out of gas at 25MHz
- ❑ Gain down by 3dB at 50MHz
- ❑ Solution: Use two OPA2674 in tandem

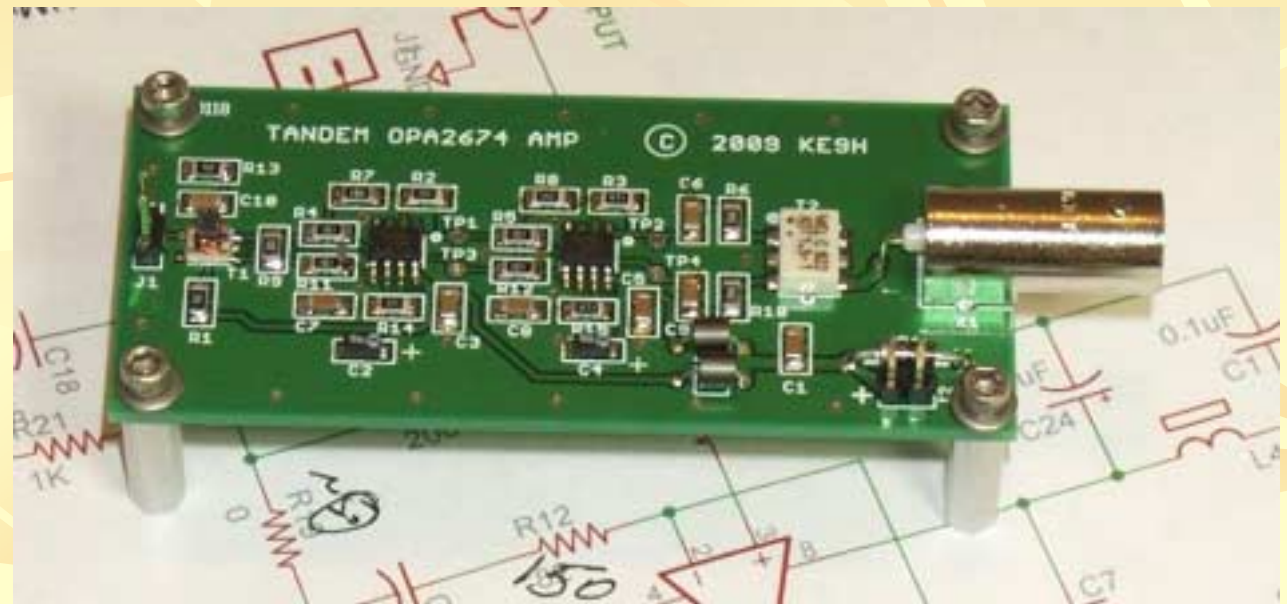



Hermes PA Testing

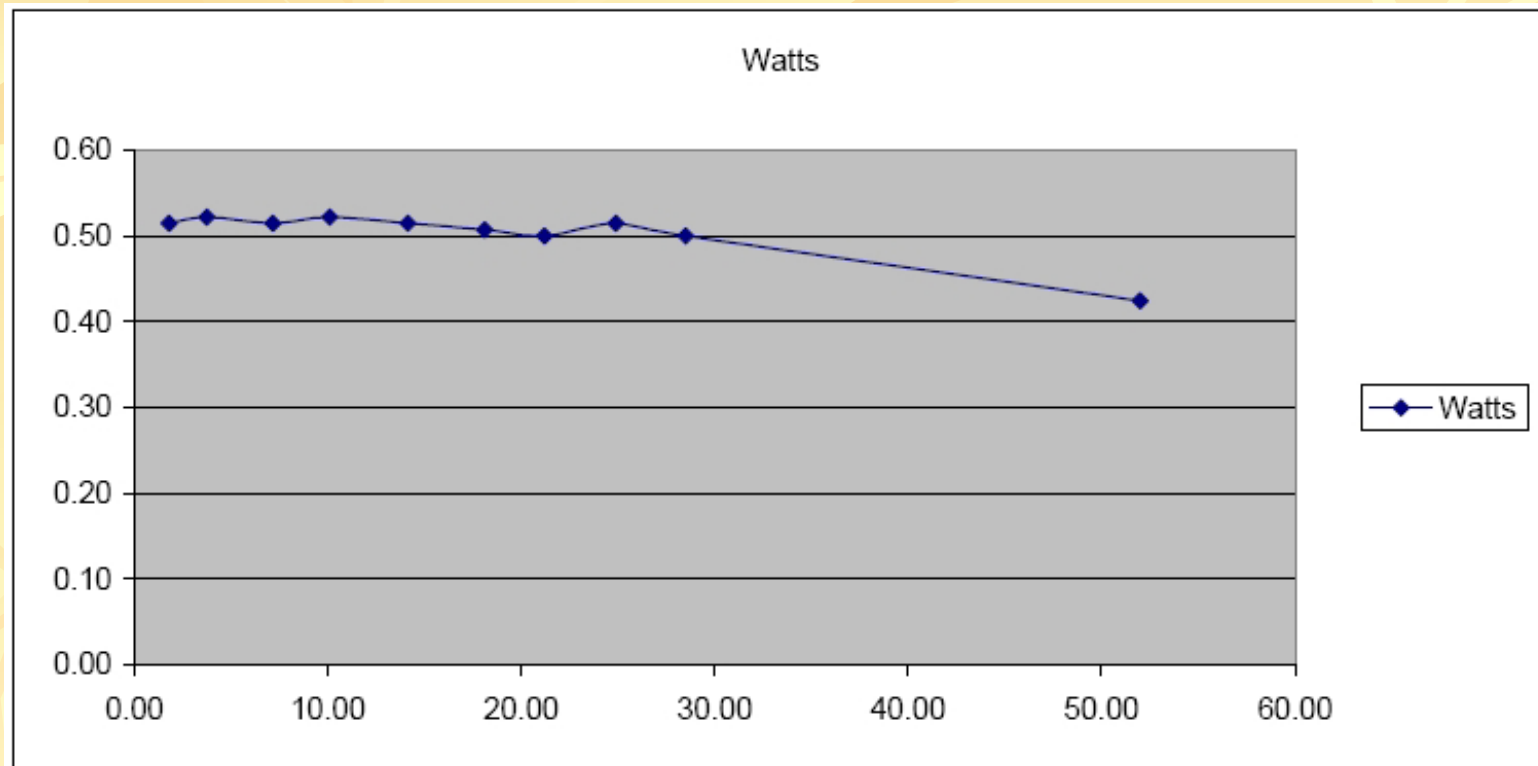

Tandem OPA2674 PA Power Output vs Frequency



Hermes PA Testing

Tandem OPA2674 PA Schematic

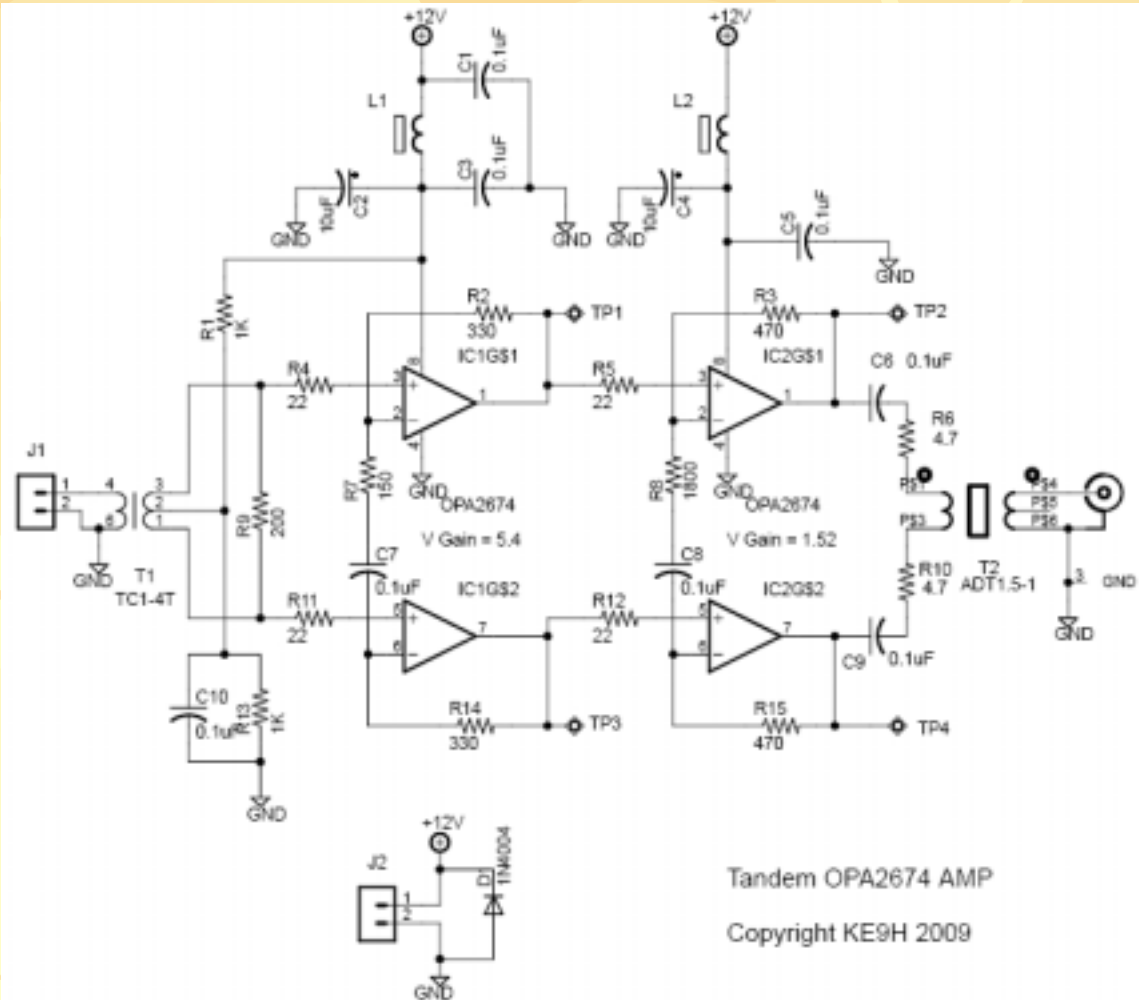



Hermes PA Testing

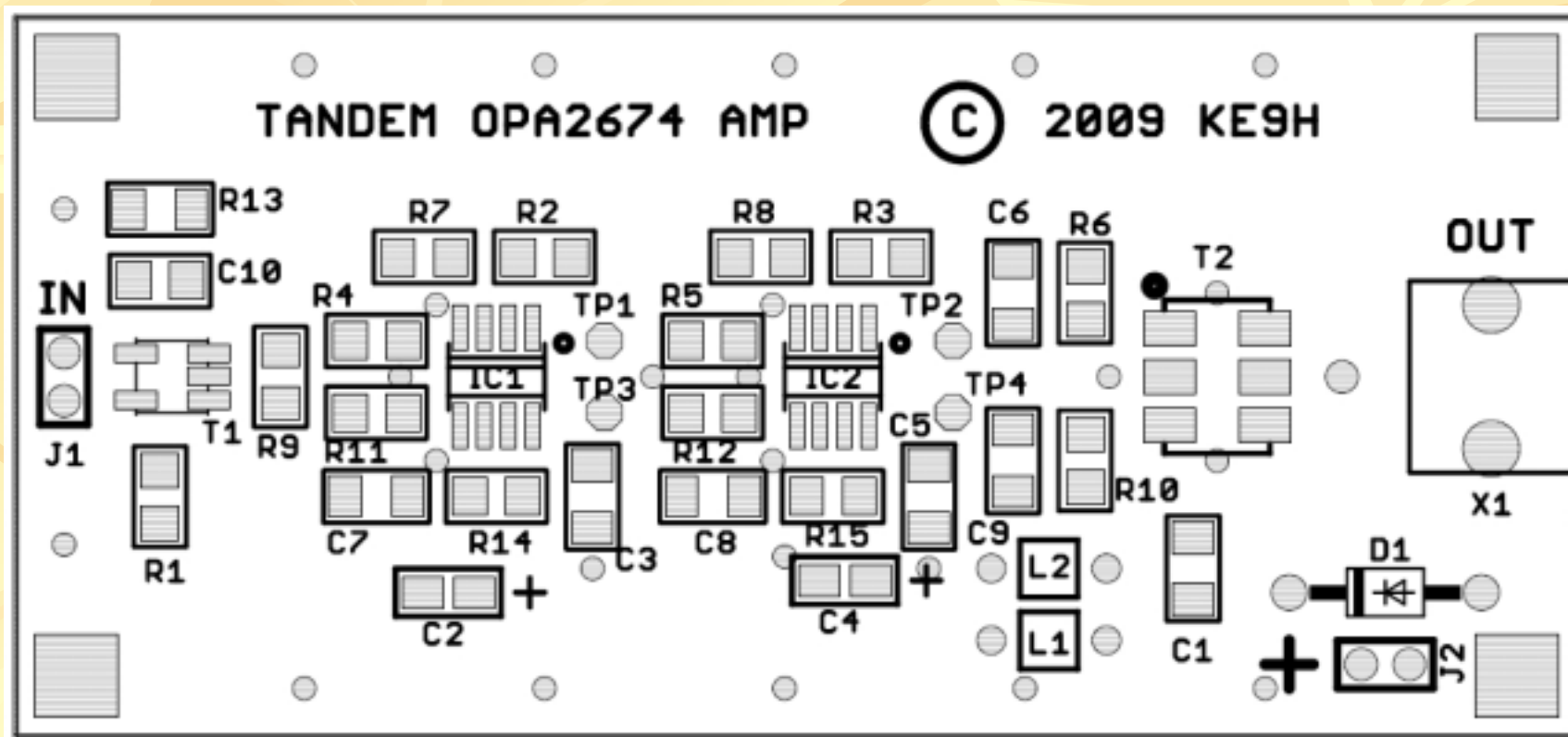

Tandem OPA2674 PA Layout



Apollo PA-LPF-ATU

Single-board 15W PA/Low Pass Filter/ATU

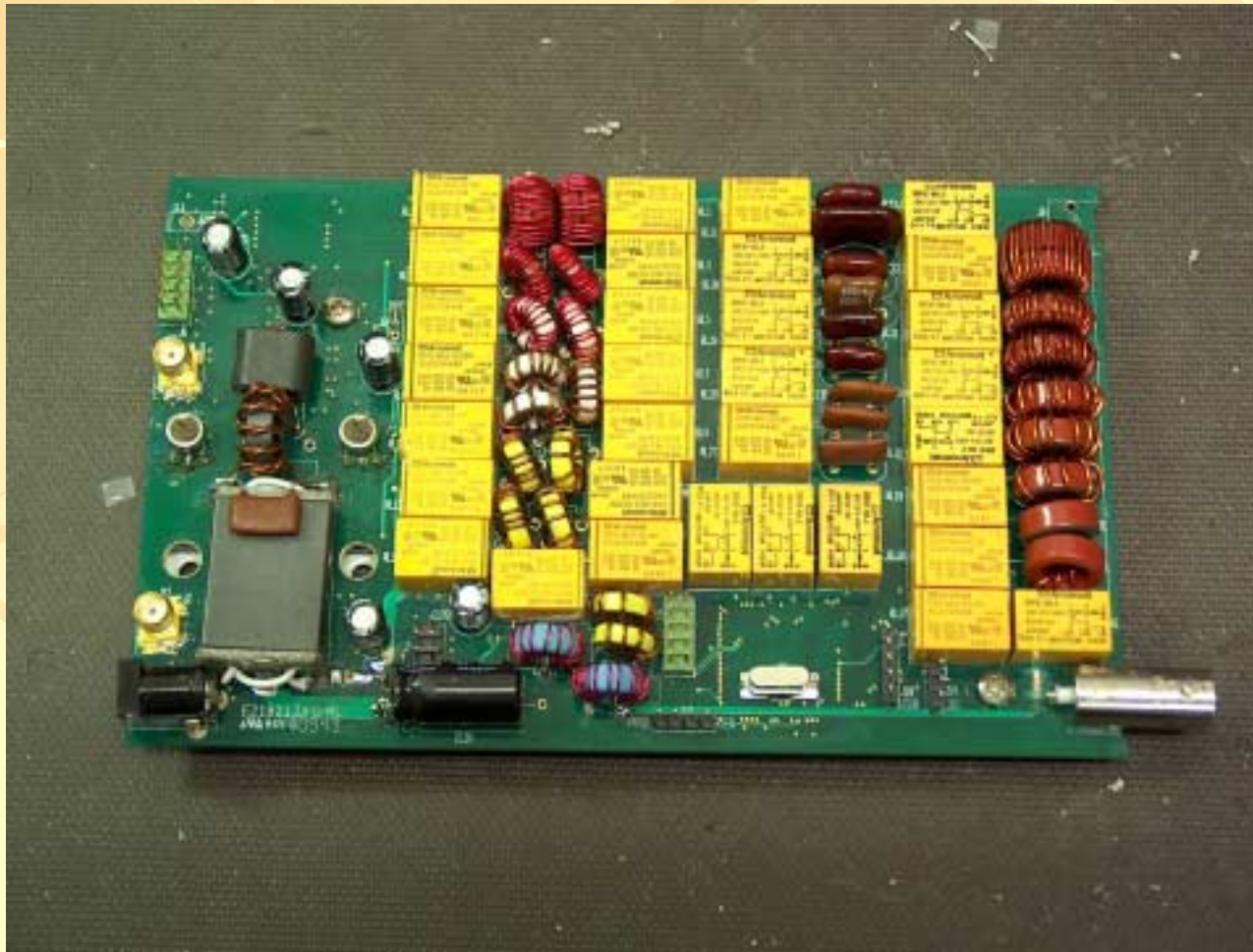



Apollo PA-LPF-ATU

Single-board 15W PA/Low Pass Filter/ATU

- ❑ Combine with Hermes for a single box OpenHPSDR transceiver
- ❑ 15W PA based on Pennywhistle design
- ❑ Low Pass Filters based on Alex design at reduced power
- ❑ SPI control from Hermes DUC/DDC Transceiver board
- ❑ Low-power automatic Antenna Tuning Unit using Atmel AVR MCU
- ❑ Standard 100mm x 160mm EuroCard

Status:

Prototype built and undergoing testing

ATU code under development

Planned for release with Hermes



SDR-in-a-box

Well, almost!

Hermes and Apollo share
a standard enclosure

(Can you find the PC in
this picture?)

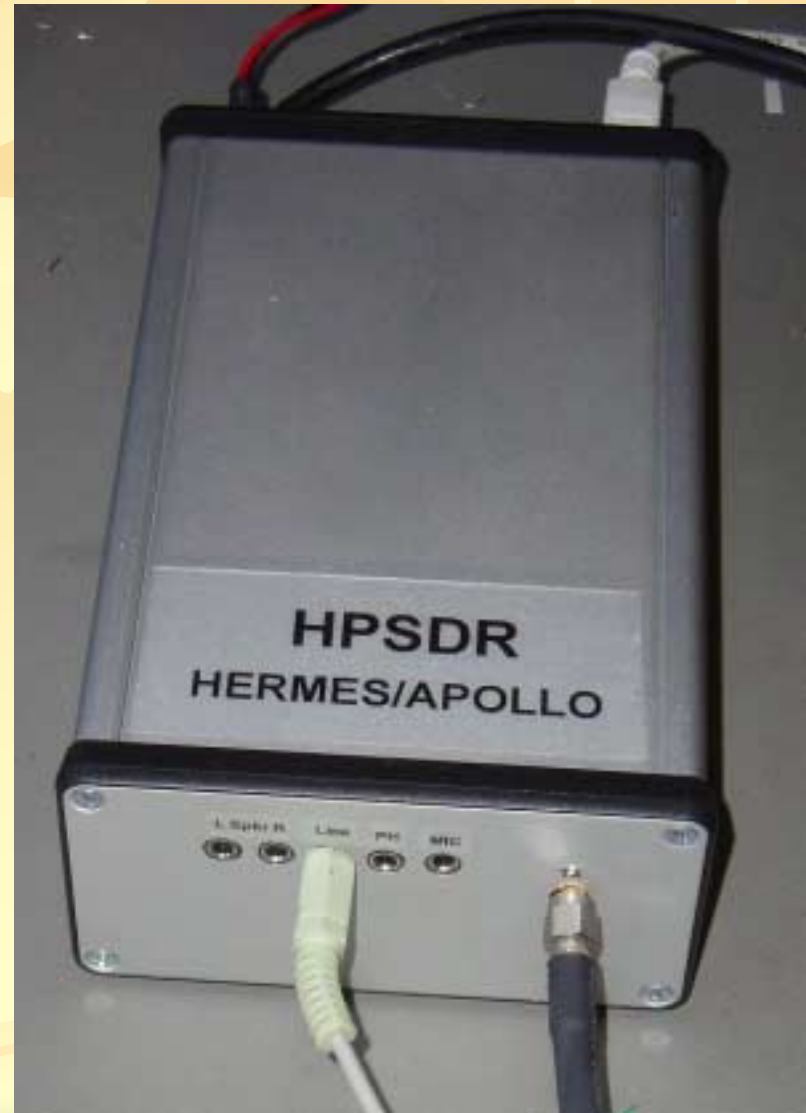



Aussie II

Gigabit Ethernet Interface

- ❑ Micrel KSZ9021RL Gigabit PHY
- ❑ Altera EP3C40 FPGA
- ❑ High-speed replacement for Ozy or Magister
- ❑ Standard 120mm x 100mm Atlas plug-in board

Status:

Prototype built by VK6APH using Micrel GE PHY Eval board

UDP/IP, DHCP, ARP, ping implemented in FPGA

KISS Konsole modified to use Ethernet instead of USB

KK7P is currently laying out the PCB



Aussie II

Gigabit Ethernet Interface

Micrel
KSZ9021
Evaluation
Board

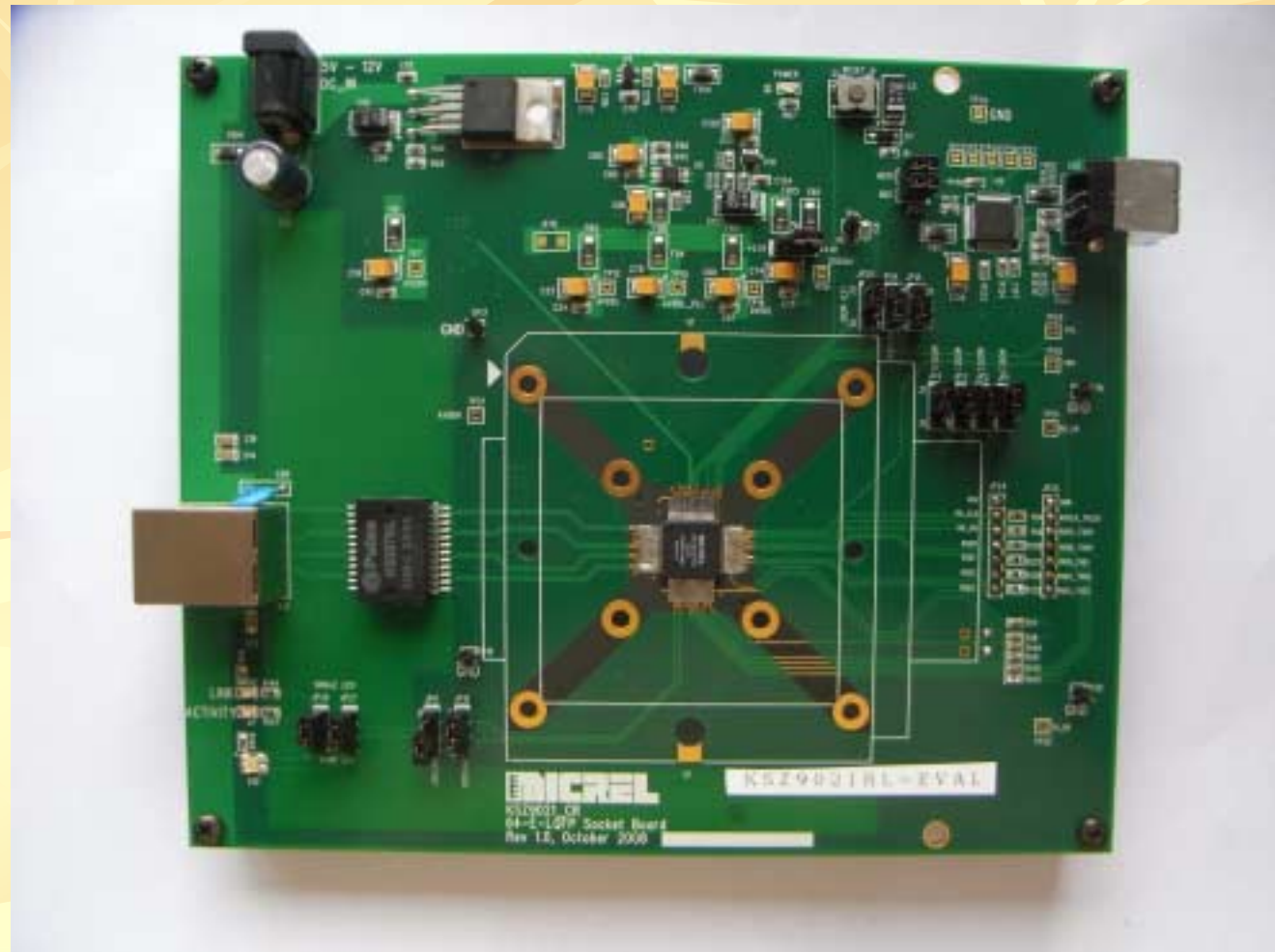



Aussie II

Gigabit Ethernet Interface

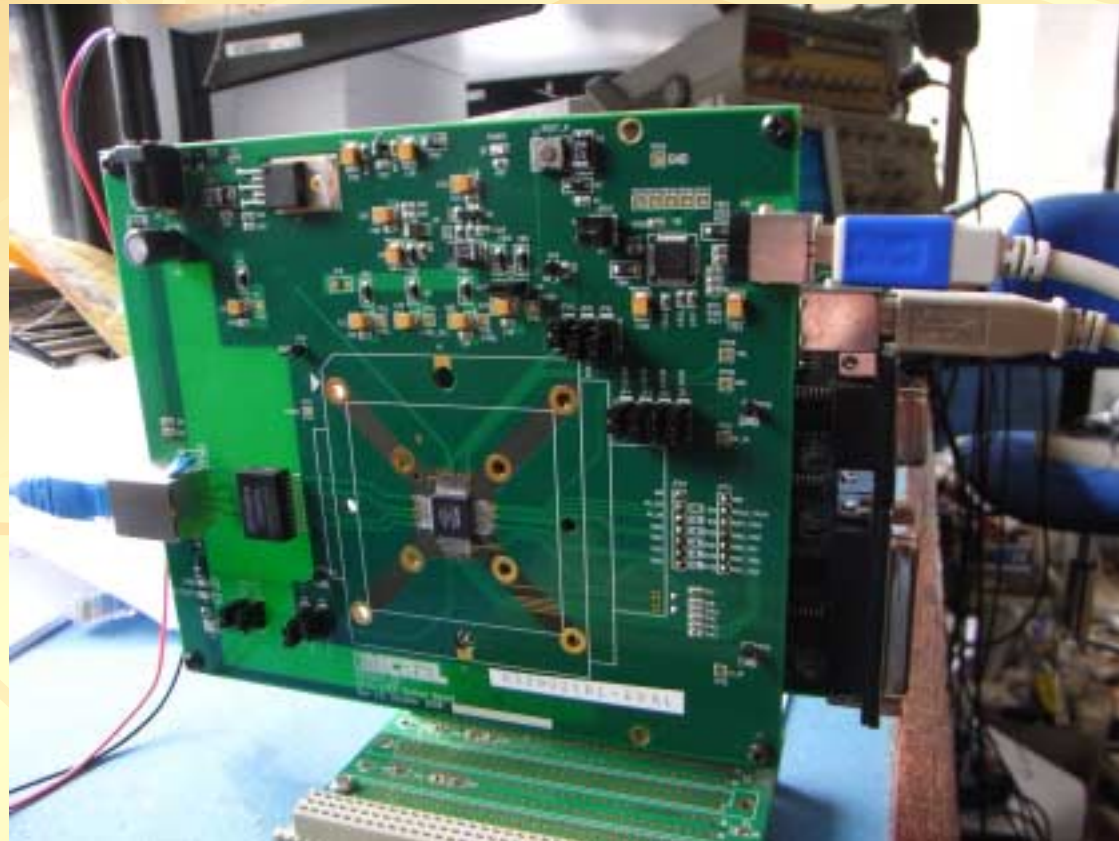

Micrel KSZ9021 Evaluation Board Piggy-backed onto Ozy



Aussie II

SUCCESS!

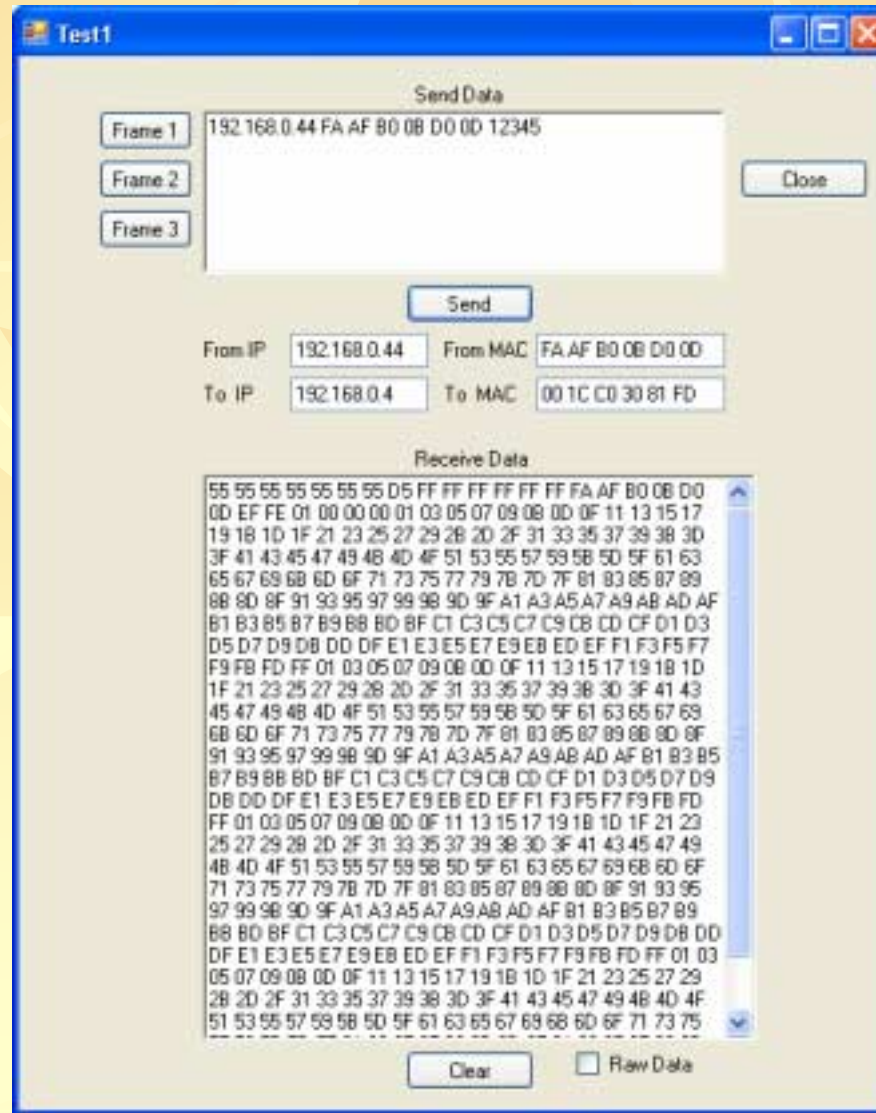



Multiple Receivers

For those with more than twice as many ears as noses...

- FOUR independent receivers can reside on OpenHPSDR Mercury
- Hermes can support EIGHT receivers due to its increased size
- How does this work?
 - High-speed ADC digitizes entire 54MHz wide spectrum
 - FPGA creates separate 192kHz wide data stream for each receiver
 - PC demodulates each data stream as a separate virtual receiver

Since each data stream is created from all of the HF data, each virtual receiver is fully independent: frequency, mode, bandwidth, AGC, etc



Multiple Receivers

Screen
Shot
from
Ken,
N9VV

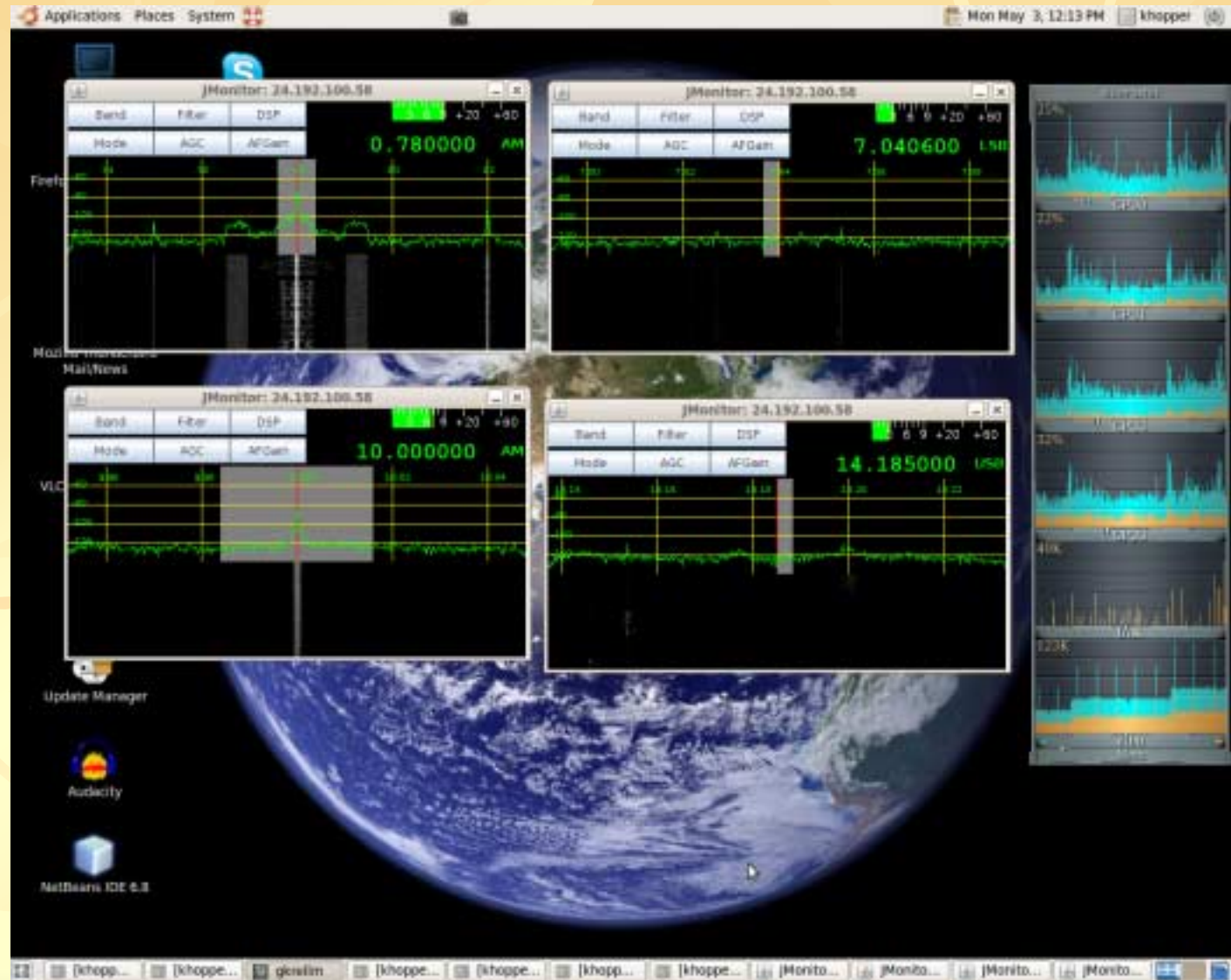



Multiple Receivers

Wait, there's more: they're on the Internet!

- John, G0ORX/N6LYT receivers URL:

<http://g0orx.homelinux.net/jmonitor.html>

- Ken, N9VV receivers URL:

<http://24.192.100.58/jmonitor.jnlp>

- Want to run your own server? Ken, N9VV shows you how:

<http://www.n9vv.com/N6LYT%20Online%20Mercury%20Receiver.pdf>



Multiple Receivers

Modest Server Hardware Requirements

Ken's system is straight-forward:

- ❑ Mini-ITX motherboard with 1.6GHz Atom N330, 1GB DDR2 DRAM
- ❑ Atlas/Ozy/Mercury with mITX SMPS running from laptop brick
- ❑ Multi-RX FPGA code for Mercury
- ❑ Ubuntu 10.04 and GHPSTR3 running on PC
- ❑ Connection to the Internet



Thank you!

Project information at: www.openhpsdr.org

Interest list at: www.hamsdr.com

Boards available at: www.tapr.org